

Patterns... Your Way!™

Pattern Catalog

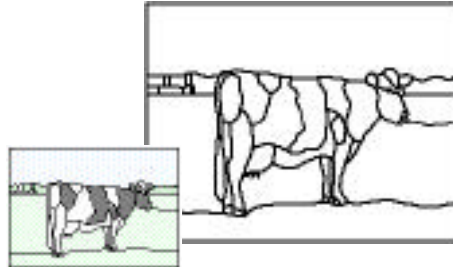

We make patterns the way you need them!

Table of Contents

How to Use This Catalog and Place Orders

How to Custom Size a Pattern

Patterns (*Patterns shown are not all to same scale. Some are reduced more than others from their standard sizes.*)

Appendix A: Prices, Standard Sizes, Ranges of Acceptable W/H Ratios, N^o. of pieces in pattern.

Appendix B: How To Submit Patterns for future catalog updates.

Back: Order Forms--Samples only since you can't print this PDF.

Patterns in this catalog can be ordered to the EXACT size needed.
Charge for custom sizing is just \$6.

Standard Paper Sizes (Print Area)

	23.5" x 34.5"	59.7 cm x 87.6 cm	
	23.5" x 46.5"	59.7 cm x 118.1 cm	
(1 inch = 2.54 cm)	35.5" x 46.5"	90.2 cm x 118.1 cm	(1 cm = 0.3937 inch)

Custom sized patterns larger than these paper sizes are printed on more than one sheet, requiring you to tape the pages together for the full-size pattern. (An alignment guide is printed on multiple page patterns for precise alignment.) Patterns are printed to a tolerance of ± 0.05 ". Maximum enlargement: size is 100" x 100".

Digital Version of this Catalog

This catalog is also available in color in digital format using Adobe's Acrobat. You need Acrobat Reader (available free from Adobe's web site at www.adobe.com) to view the file*. With the digital format you can search the entire catalog instantly to find pattern subjects if you downloaded Acrobat Reader with the search feature.

*If you have a computer with a CD Rom, Acrobat Reader is also available on a single CD Rom for Windows 3.1, Windows'95, Macintosh, UNIX, HP-UX, IBM-AIX, SunOS, and IRIX platforms. Send us \$7 for the Acrobat Reader CD Rom and the digital version of this catalog on 3.5" diskettes (PC or Mac). If you already have Acrobat Reader with Search, send \$5 for just the digital version of this catalog on 3.5" diskettes (specify PC or Mac.)



Patterns...Your Way!™

We make patterns the way you need them!

1153 Yale Ave Modesto CA 95350-5850 209-409-3850 FAX: 209-529-0632 e-mail: service@patternsnyw.com
Place orders from ONLINE catalog (www.patternsnyw.com) -- we no longer accept fax orders.

How to Use This Pattern Catalog

Placing orders is easy. Visit our web site (www.patternsnyw.com) and place your orders from our online catalog. Your pattern order will be e-mailed to you as a PDF file and attached to the e-mail letter we send you when we've processed your order. You then print, trim & tape for full pattern.

Patterns are printed without the shading shown in the catalog.

You can have each pattern printed to the EXACT size you need. (Remember to allow for the projects perimeter comes when specifying the size you need. Patterns are printed to the size you order!) See the next section for custom-sizing a pattern to your needs.

How to Custom Size a Pattern

While we can print any pattern to any dimensions, it might not look correct if you exceed the range of acceptable proportions. Here's how to decide which pattern will work for your need:

- 1) Calculate the width and height for your project.
- 2) Divide the Width by the Height. This is your W/H Ratio. For example, if you need a pattern for a 12" wide by 60" high window, your W/H Ratio = 12/60, or 0.20.
- 3) Choose a pattern for which your W/H Ratio is within the Acceptable W/H Range as shown for each pattern in the back of the catalog. For example, a pattern with the range of Min=0.15 to Max=0.45 will work fine for your application with a 0.20 W/H Ratio. If you are outside of the recommended range, you can still order the pattern, as long as you give us permission to process the order by checking the appropriate box on the order form.
- 4) Check to be sure your size request is larger than the Minimum recommended pattern width. This will assure that the pieces in the pattern are not too small to cut. The Minimum Recommended Widths are set for experienced glass cutters.

When custom sizing patterns, keep in mind that circles (W/H=1.0) become ovals if you specify unequal width and height. Squares become rectangles with unequal side & top borders. Octagons become elongated octagons, semi-circles become semi-ovals, and so forth. We can not custom modify designs. Only the width and height can be modified.

Here are examples of W/H Ratios:
(Ratios shown inside shape)

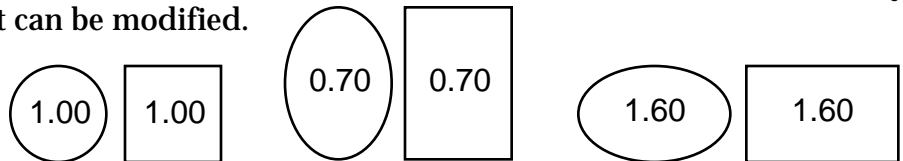

Below is an example to help you understand the Acceptable W/H Ratio Range:

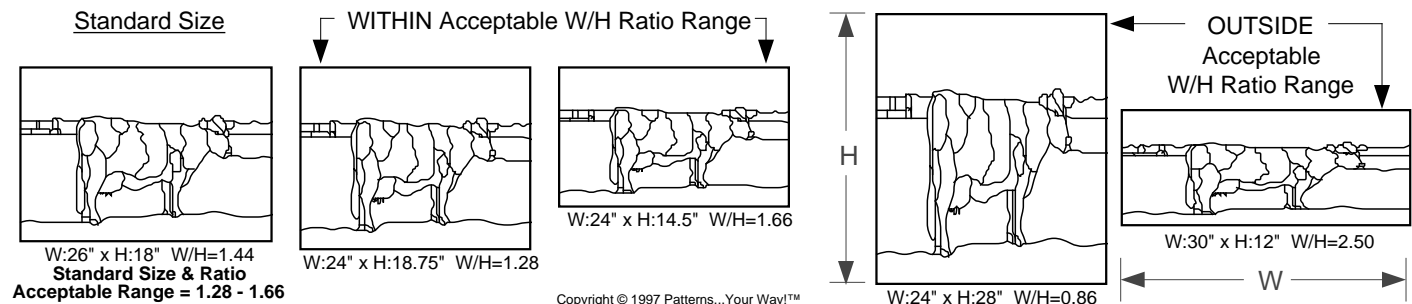



#02-07 IRISES
© Karen K. Charles, La Mesa NM

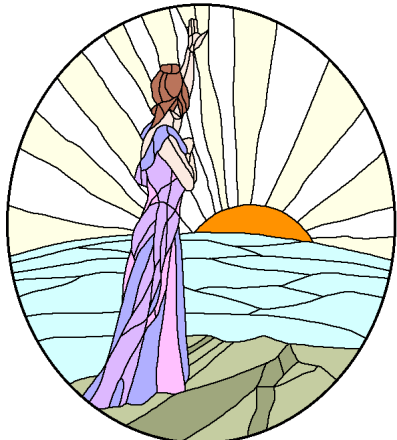

#11-225 CALLING UP THE LIGHT
© Paula Zan, Mythling Studio, Hyndman PA

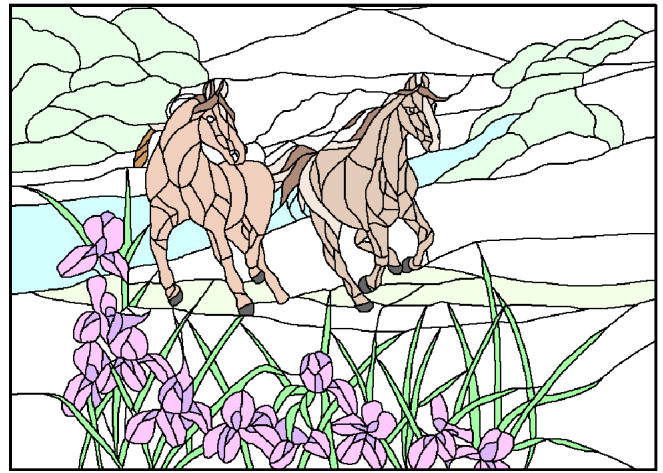

#02-04 RIVER HORSES
© Karen K. Charles, La Mesa NM



#02-02 ROPIN' COWBOY -1

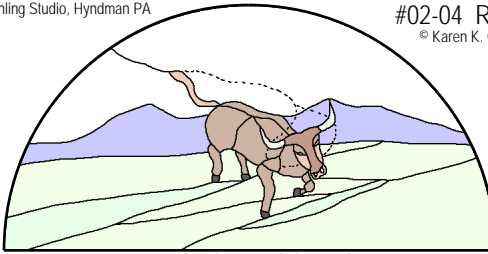

#02-03 ROPIN' COWBOY -2
© Karen K. Charles, La Mesa NM

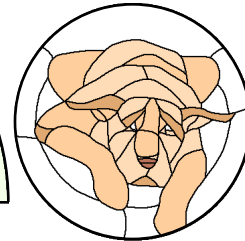

#11-063 PENITENT POOCH
© Paula Zan, Mythling Studio, Hyndman PA

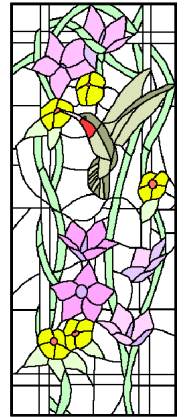

#11-131 HUMMINGBIRD & TRELIS
© Paula Zan, Mythling Studio, Hyndman PA

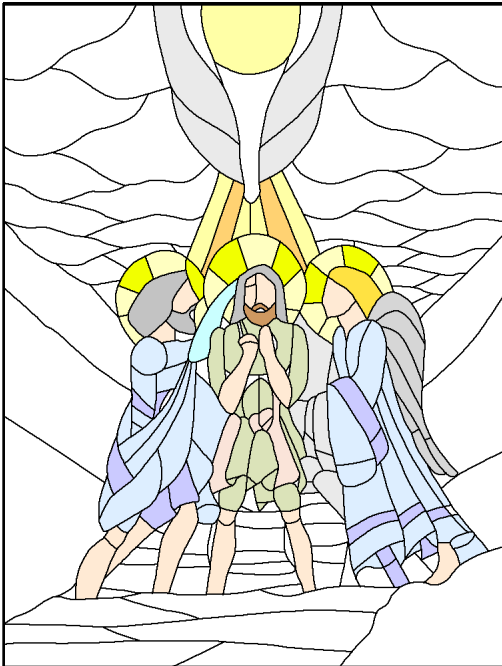

#20-04 BAPTISM OF JESUS
© Margaret Canrell, Detail & Design, Farmiland IN

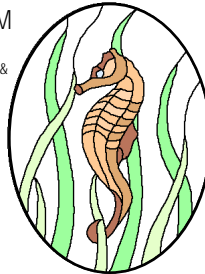

#04-19 SEA HORSE
© Robert Burrows, Gremlin Glass, Ridgcrest CA

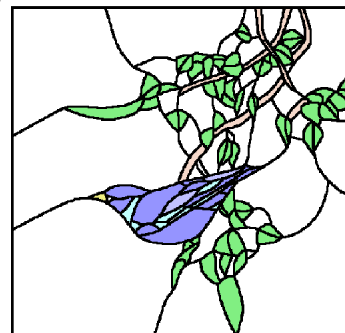

#11-095 BLUEBIRD
© Paula Zan, Mythling Studio, Hyndman PA

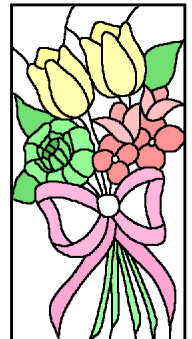

#06-31 FLORAL BOUQUET
© Darcie Rummell, Cambria Glass & Insulation Inc., Johnstown PA

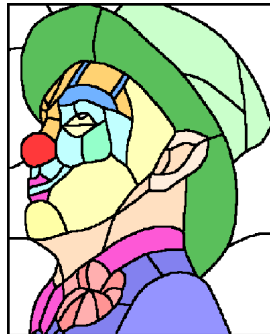

#11-097 DAPPER CLOWN
© Paula Zan, Mythling Studio, Hyndman PA

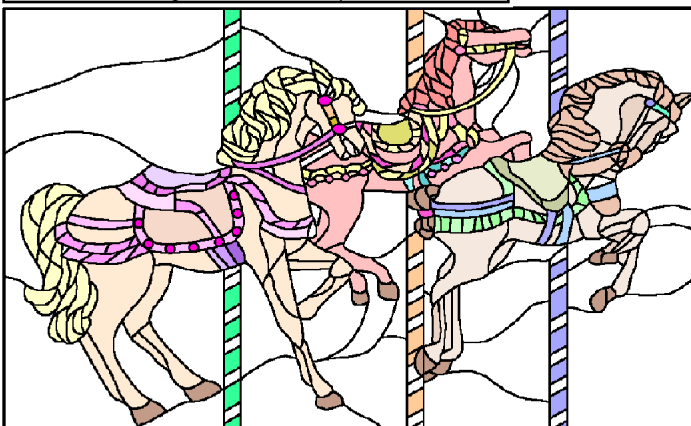

#25-512 CAROUSEL HORSES THREE IN PROFILE
© Aurora Publications, Cal Studio, San Jose CA

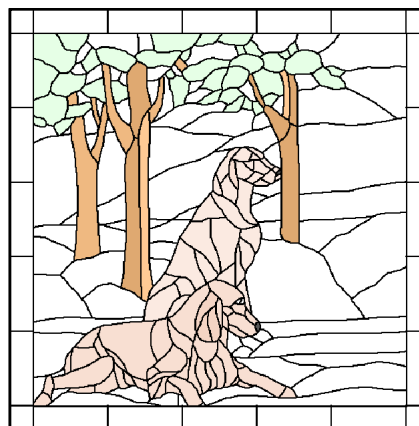

#11-223 IRISH SETTLERS' DAY'S END
© Paula Zan, Mythling Studio, Hyndman PA

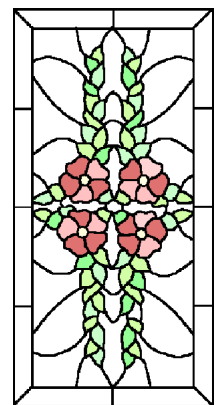

#06-41 FOUR FLOWER DESIGN
© Darcie Rummell, Cambria Glass & Insulation Inc., Johnstown PA

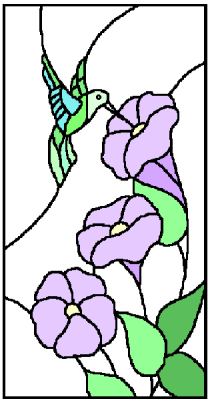

#06-38 HUMMINGBIRD & MORNING GLORIES
© Darcie Rummell, Cambria Glass & Insulation Inc, Johnstown PA

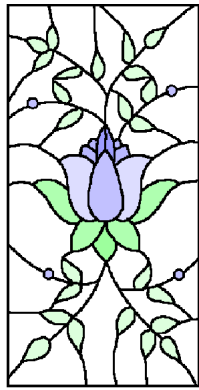

#06-43 MODERN TULIP & LEAVES
© Darcie Rummell, Cambria Glass & Insulation Inc, Johnstown PA

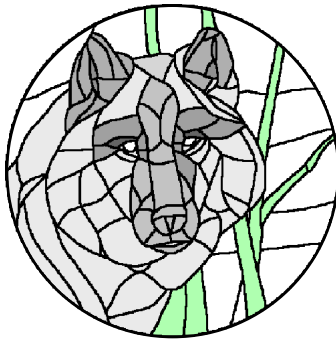

#11-098 TIMBER WOLF
© Paula Zan, Mything Studio, Hyndman PA



#11-065 THE WIZARD
© Paula Zan, Mything Studio, Hyndman PA

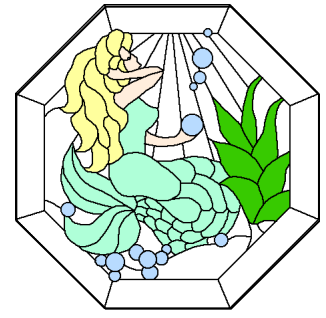

#03-08 UNDERWATER MERMAID
© Carol Miller Cussins, Winchester OH

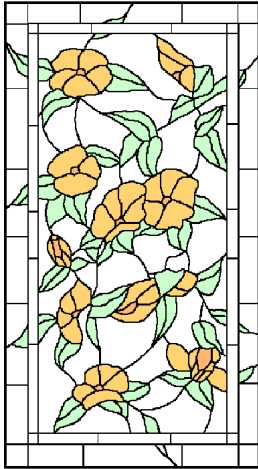

#02-05 DOGWOOD WITH BEVELS
© Karen K. Charles, La Mesa NM

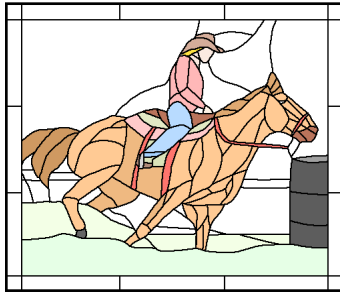

#11-115 BARREL RACER
© Paula Zan, Mything Studio, Hyndman PA

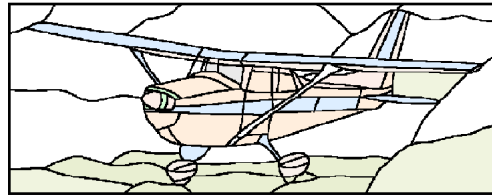

#11-169 CESSNA SKYHAWK
© Paula Zan, Mything Studio, Hyndman PA

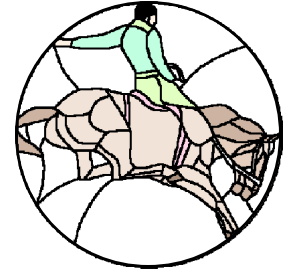

#11-105 SADDLE BRONCO
© Paula Zan, Mything Studio, Hyndman PA

#14-23 INDIAN & MESA (MY BACKYARD)
© Roger E. Derden, Stained Glass Studio, Livingston TX



The Zan Zoo

Collection :

Add Your Choice of Beasts to a Zan Zoo Africa Scene!



#11-196 AFRICAN GRASSLAND-1
ADD A BEAST: UP TO 3 ANIMALS
© Paula Zan, Mything Studio, Hyndman PA

#11-196 AFRICAN HIPPOPOTAMOS
© Paula Zan, Mything Studio

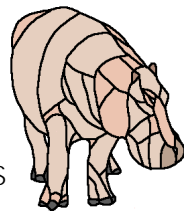

#11-199 AFRICAN RHINOCEROS
© Paula Zan, Mything Studio

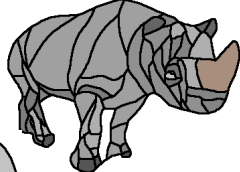

#11-201 AFRICAN LION
© Paula Zan, Mything Studio



#11-200 HIPPOPOTAMOS
© Paula Zan

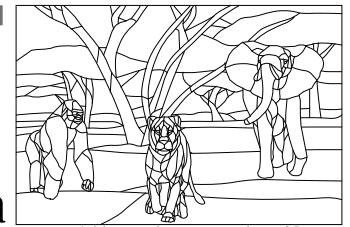
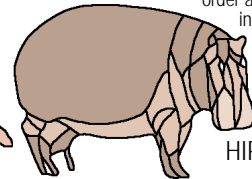

Add up to the max number of Beasts shown for each scene - - Specify Beasts by Beast Number, in order as they are to appear in pattern (left to right)

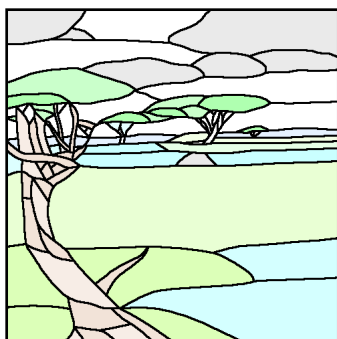

#11-191 AFRICAN ELEPHANT
ADD A BEAST: CHOOSE A BEAST (1)
© Paula Zan, Mything Studio, Hyndman PA

#11-191 AFRICAN ELEPHANT
© Paula Zan, Mything Studio

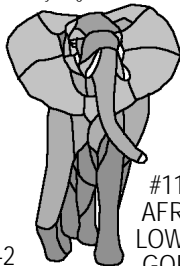

#11-198 AFRICAN LOWLAND GORILLA
© Paula Zan, Mything Studio

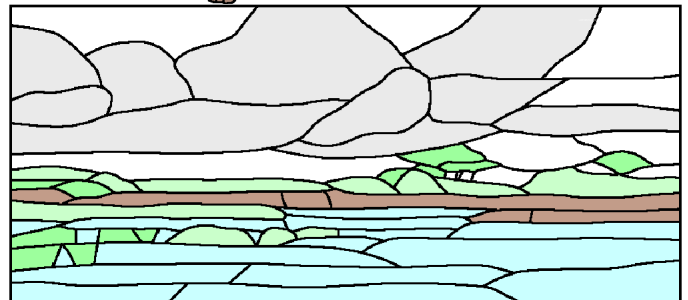
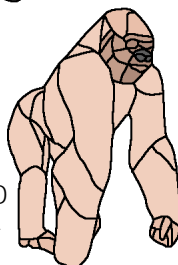

#11-910 AFRICAN GRASSLAND & WATERHOLE
ADD A BEAST: UP TO 3 ANIMALS
© Paula Zan, Mything Studio, Hyndman PA

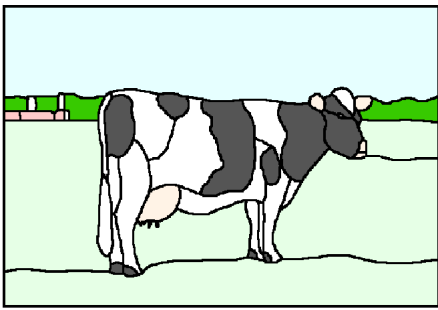

#01-01 DAIRYMAN'S DREAM COW
(The Patterns... Your Way!™ Logo)
© Dale Lerch, Sierra Stained Glass Studios Inc, Modesto CA

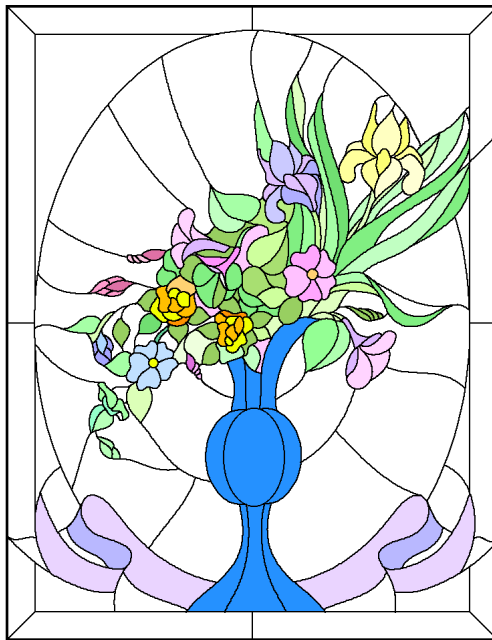

#20-91 FLOWER BOUQUET
© Margaret Cantrell, Detail & Design, Farmland IN



#25-646 SANTA
© Aurora Publications, Cal Studio, San Jose CA

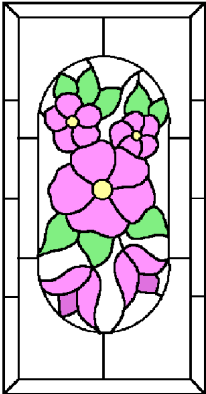

#06-40 FLOWER CLUSTER
© Darcie Rummell, Cambria Glass & Insulation Inc, Johnstown PA



#04-13 HOT AIR BALLOONS
© Robert Burrows, Gremlin Glass, Ridgecrest CA

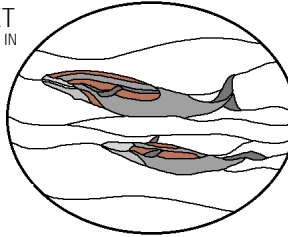

#04-11 TWO WHALES
© Robert Burrows, Gremlin Glass, Ridgecrest CA

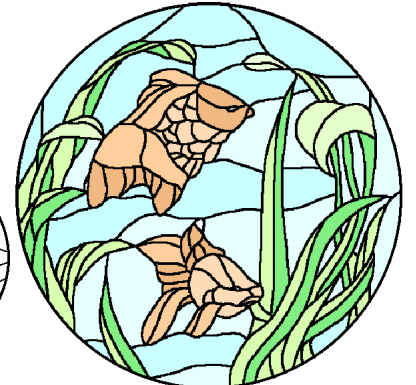

#25-600 DEEP SEA FISH
© Aurora Publications, Cal Studio, San Jose CA

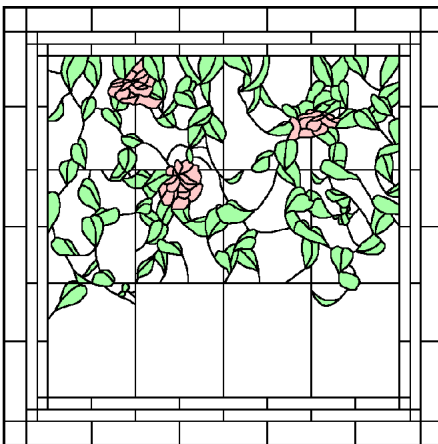

#13-04A HANGING VINES (LEFT)
© Barbara Williamson, Pane In The Glass Inc, Ft. Lauderdale FL

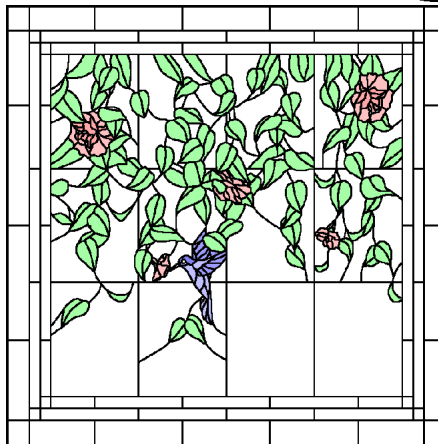

#13-04B HANGING VINES (RIGHT)
© Barbara Williamson, Pane In The Glass Inc, Ft. Lauderdale FL

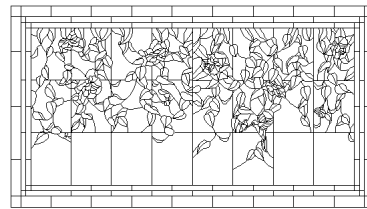

#13-05 HANGING VINES (BOTH PARTS)
© Barbara Williamson, Pane In The Glass Inc, Ft. Lauderdale FL

#11-239 PENSIVE POOCH
© Paula Zan, Mything Studio, Hyndman PA

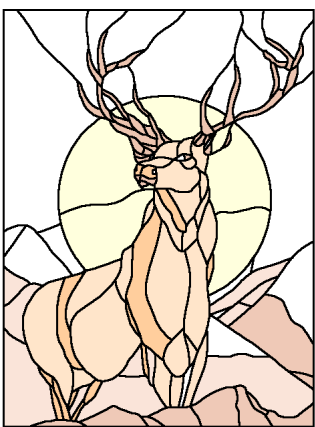
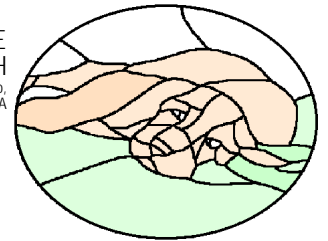

#25-594 STAG IN THE MOUNTAINS
© Aurora Publications, Cal Studio, San Jose CA



#04-17 GREEK DRAMA MASK
© Robert Burrows, Gremlin Glass, Ridgecrest CA

#21-25 CHERRY & ROOSTER
© Nena Vogl, Designer Glass by SGO, Billings MT

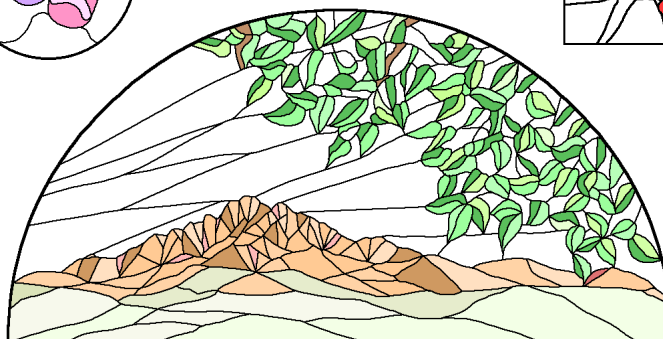

#02-06 ORGAN MOUNTAINS
© Karen K. Charles, La Mesa NM

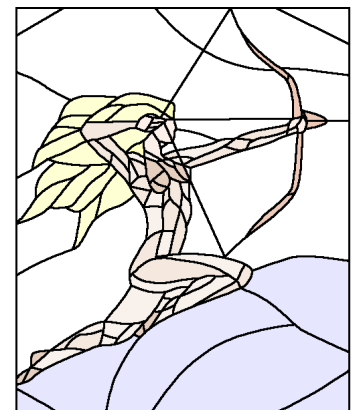

#11-080 THE HUNTRESS
© Paula Zan, Mything Studio, Hyndman PA

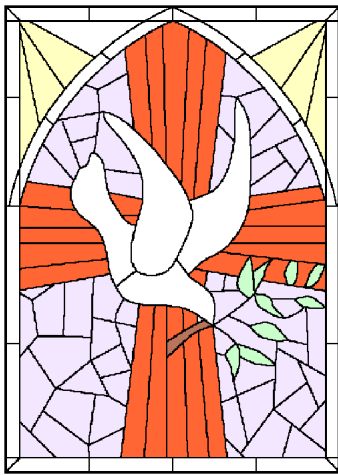

#09-60 DOVE OF PEACE
© Frank Thompson, Historical Reproduction Studio, Lake Charles LA

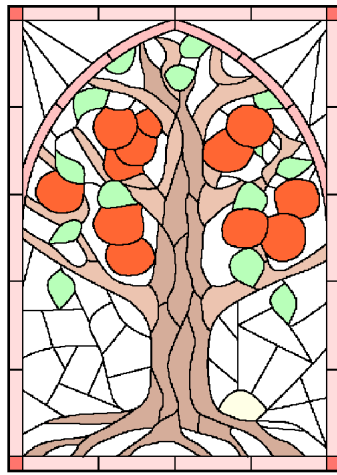

#09-61 TREE OF LIFE
© Frank Thompson, Historical Reproduction Studio, Lake Charles LA

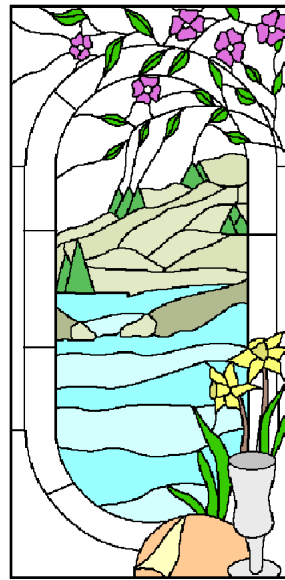

#18-68 RIVER OF LIFE WITH BREAD & CHALLIS
© Rosalie Smith, Coquille OR

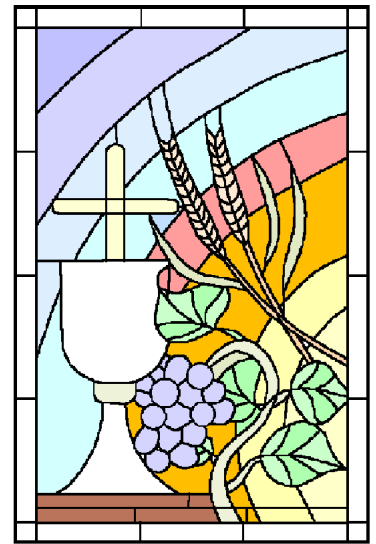

#09-56 EUCHARIST
© Frank Thompson, Historical Reproduction Studio, Lake Charles LA

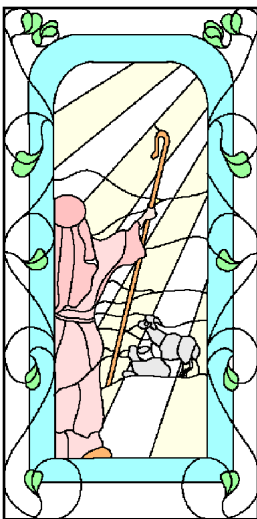

#18-66 23 THIRD PSALM
© Rosalie Smith, Coquille OR



#21-15 ANGEL MUSICIAN
© Nena Vogl, Designer Glass by SGO, Billings MT

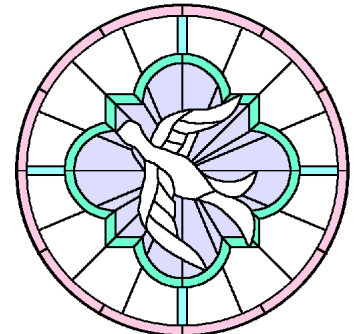

#09-58 DOVE OF JOY
© Frank Thompson, Historical Reproduction Studio, Lake Charles LA

#21-26 ASCENSION ROBE
© Nena Vogl, Designer Glass by SGO, Billings MT

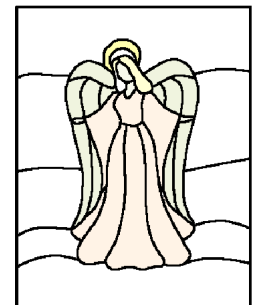

#23-32 ANGEL DIANE
© Deborah Leary, The Lighthouse Stained Glass Studio, Rochester NH

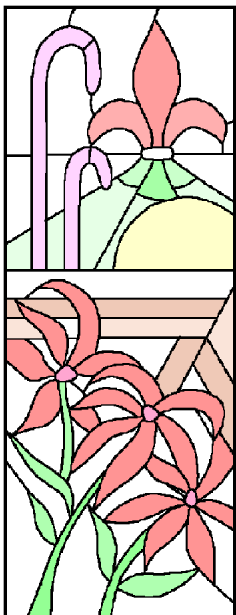

#09-52 CHRISTMAS
© Frank Thompson, Historical Reproduction Studio, Lake Charles LA

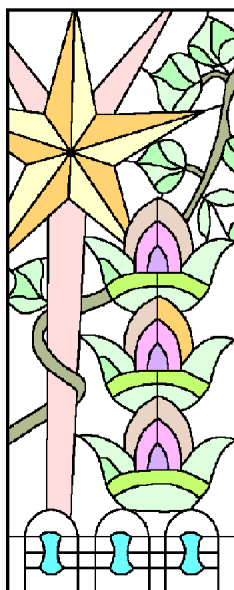

#09-51 EPIPHANY
© Frank Thompson, Historical Reproduction Studio, Lake Charles LA

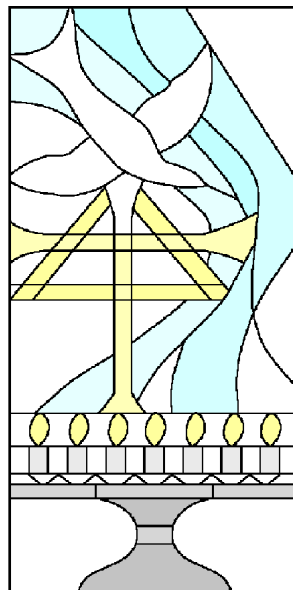

#09-49 PENTECOST
© Frank Thompson, Historical Reproduction Studio, Lake Charles LA

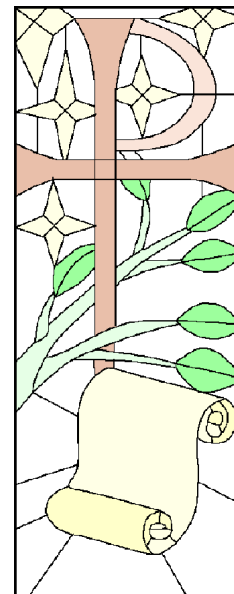

#09-47 ADVENT
© Frank Thompson, Historical Reproduction Studio, Lake Charles LA

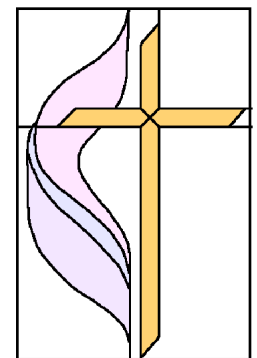

#20-07 CROSS
© Margaret Cantrell, Detail & Design, Farmland IN

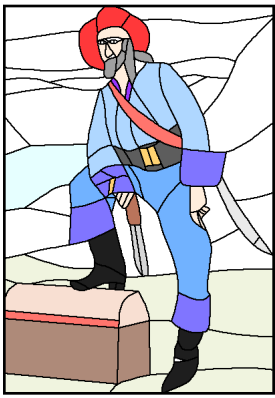

#11-086 PIRATE'S TREASURE
© Paula Zan, Mything Studio, Hyndman PA

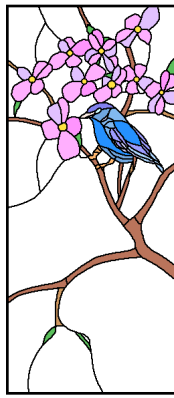

#11-149 MOUNTAIN BLUEBIRD
© Paula Zan, Mything Studio

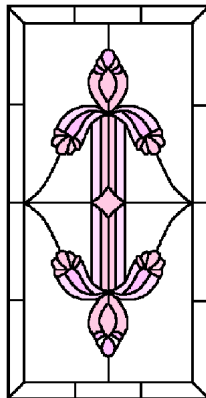

#06-42 PAISLEY DESIGN
© Darcie Rummell, Cambria Glass & Insulation Inc, Johnstown PA

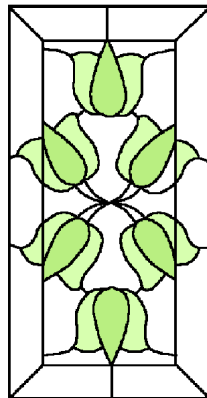

#06-36 SIX TULIP DESIGN
© Darcie Rummell, Cambria Glass & Insulation Inc, Johnstown PA



#12-74 STYLIZED FLOWER & VINES
© Charles F. Ottolini, Ottolini Studios, Sevierville TN

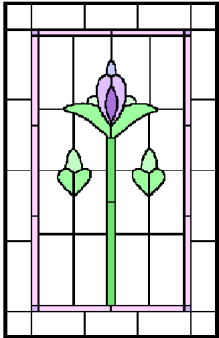

#09-57 VICTORIAN LILY
© Frank Thompson, Historical Reproduction Studio, Lake Charles LA

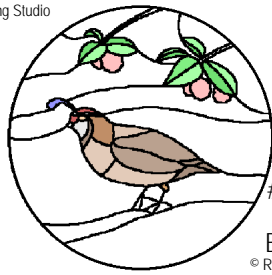

#04-21 VALLEY QUAIL & BLACKBERRIES
© Robert Burrows, Gremlin Glass, Ridgecrest CA

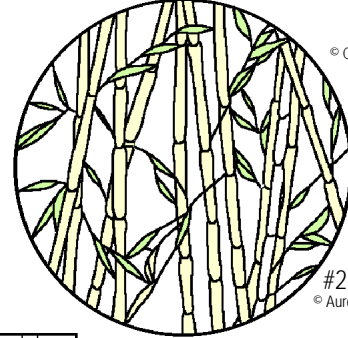

#25-515 BAMBOO
© Aurora Publications, Cal Studio, San Jose CA

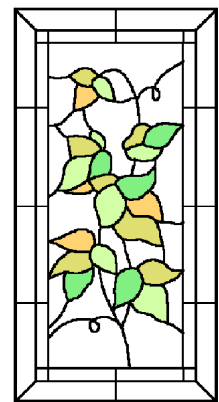

#06-37 AUTUMN IVY
© Darcie Rummell, Cambria Glass & Insulation Inc, Johnstown PA

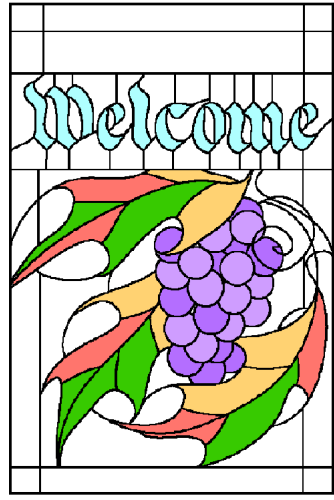

#20-92 WELCOME TO THE VINEYARD
© Margaret Cantrell, Detail & Design, Farmland IN

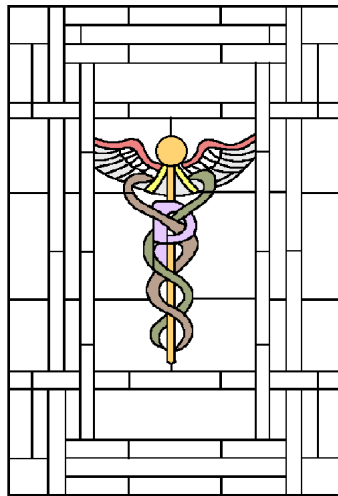

#12-78 DENTAL CADVEUS
© Charles F. Ottolini, Ottolini Studios, Sevierville TN

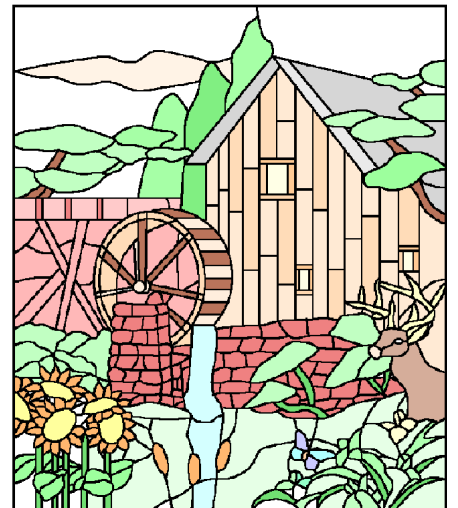

#16-55 WATERMILL SCENE WITH DEER
© Rick Hecht, SGO Designer Glass, St. Louis MO

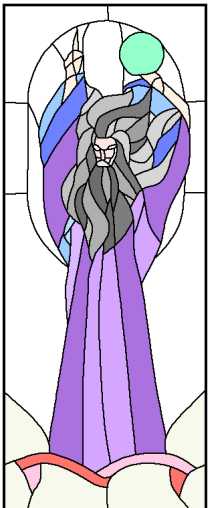

#11-093 MYTHING MAGICIAN
© Paula Zan, Mything Studio, Hyndman PA

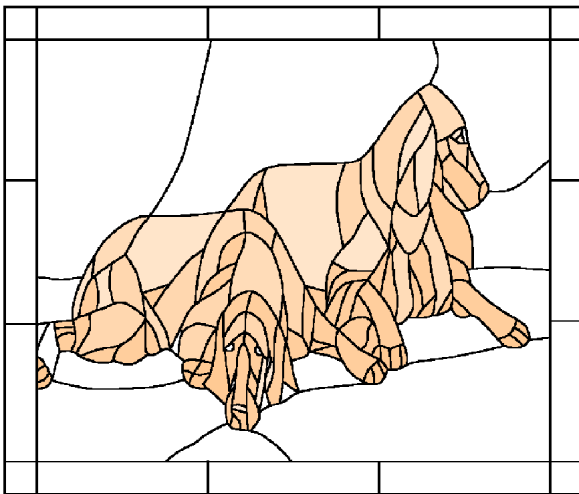

#11-077 IRISH SETTERS AT REST
© Paula Zan, Mything Studio, Hyndman PA

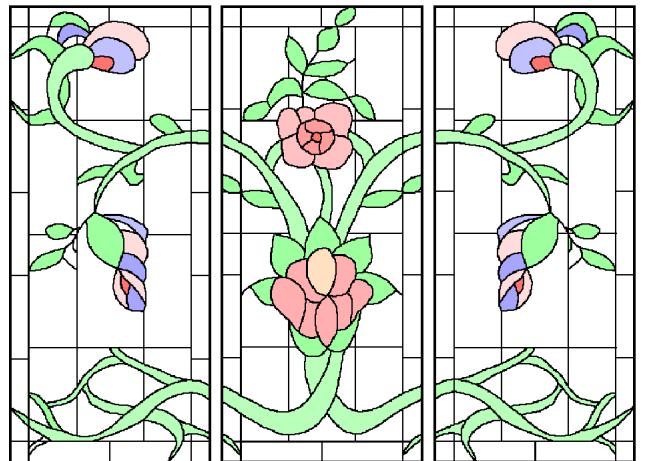

#12-83 FLORAL TRITYCH (3 PANELS)
© Charles F. Ottolini, Ottolini Studios, Sevierville TN

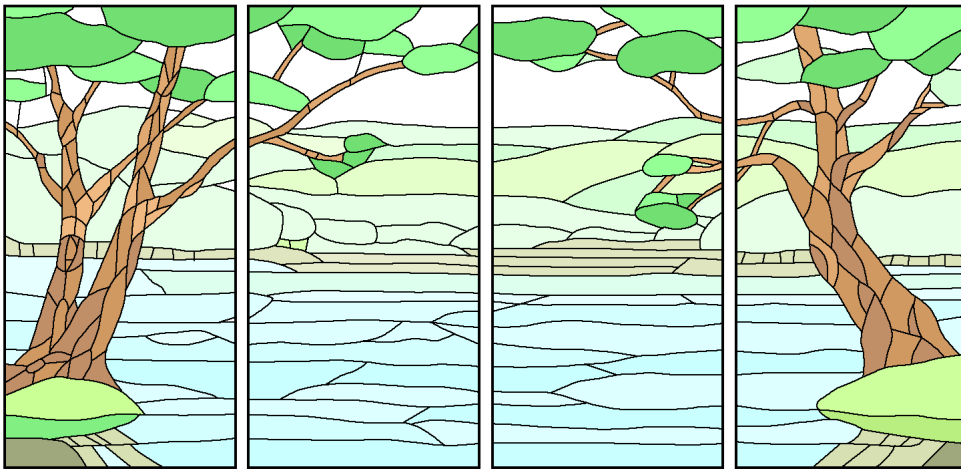

#11-125A

#11-125B

#11-125C

#11-125D

#11-125 MOUNTAIN LAKE REFLECTIONS (SET OF 4)
CAN BE ORDERED SEPARATELY (A-D)
© Paula Zan, Mythling Studio, Hyndman PA

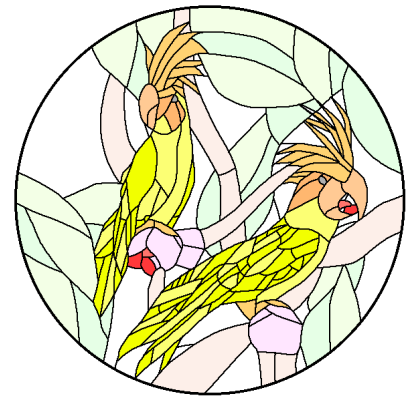

#11-099 BLACK PALM COCKATOOS
© Paula Zan, Mythling Studio, Hyndman PA

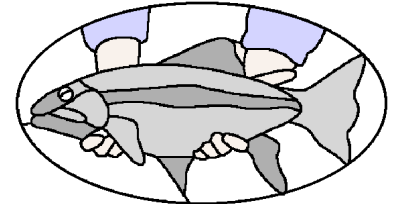

#21-21 FISH
© Nena Vogl, Designer Glass by SGO, Billings MT

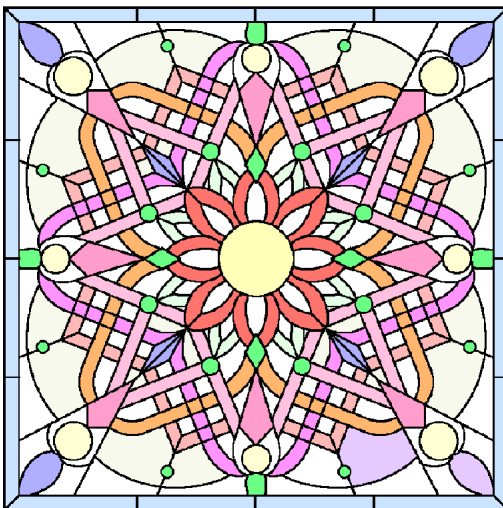

#23-38 GEOMETRIC SKYLIGHT

© Deborah Leary, The Lighthouse Stained Glass Studio, Rochester NH



#21-20 WATERWHEEL

© Nena Vogl, Designer Glass by SGO, Billings MT

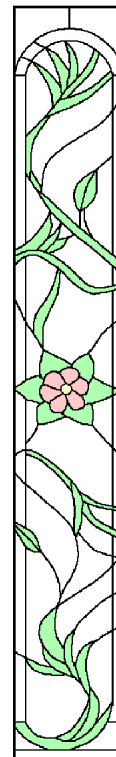

#12-86 SIDELIGHT WITH FLOWER & LEAVES

© Charles F. Ottolini, Ottolini Studios, Sevierville TN

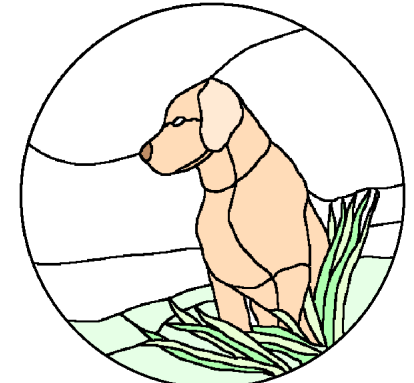

#18-72 GOLDEN LABRADOR

© Rosalie Smith, Coquille OR



#25-601 FISH & LURE

© Aurora Publications, Cal Studio, San Jose CA

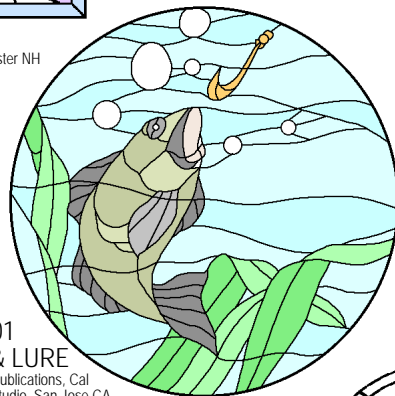

#04-12 BIRD OF PARADISE

© Robert Burrows, Gremlin Glass, Ridgecrest CA

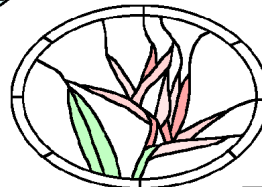

#25-615 GEISHA WITH LANTERN

© Aurora Publications, Cal Studio, San Jose CA

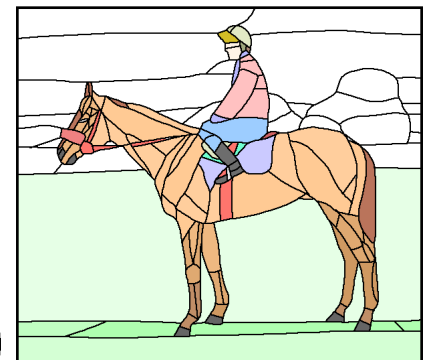

#11-101 THE WINNER

© Paula Zan, Mythling Studio, Hyndman PA

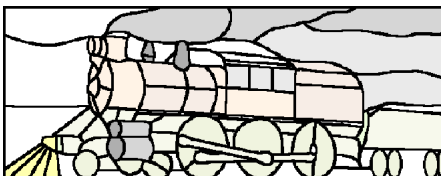

#11-148 STEAM LOCOMOTIVE

© Paula Zan, Mythling Studio, Hyndman PA

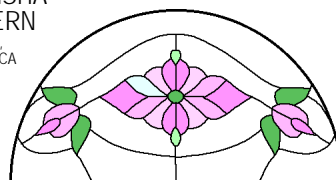

#16-50 1/2 GEOMETRIC DOOR LITE

© Rick Hecht, SGO Designer Glass, St. Louis MO

#25-667 ROADSTER

© Aurora Publications, Cal Studio, San Jose CA

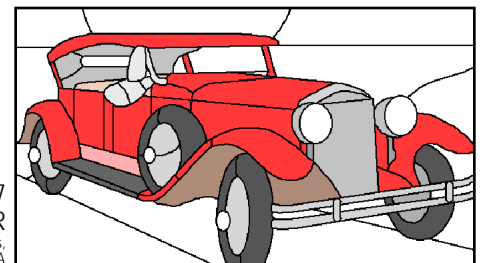

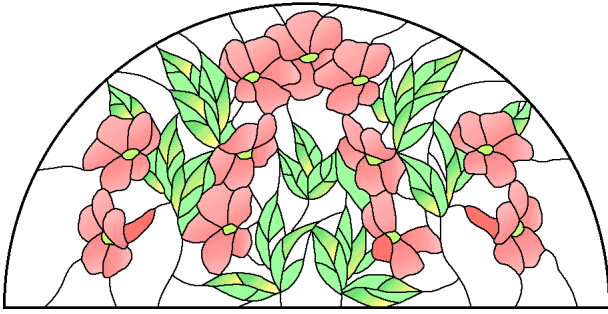

#07-15 FLOWER JUNGLE
© Rita Jean Zippo, Magic Glass by Jean, Tamarac FL

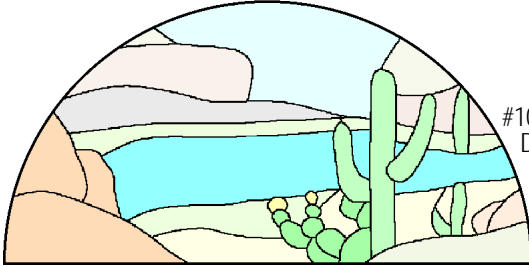

#10-40 DESERT VIEW
© Gabriel Venegas- Lopez, Sierra Stained Glass Studios Inc, Modesto CA



#07-10 CALLA LILIES
© Rita Jean Zippo, Magic Glass by Jean, Tamarac FL

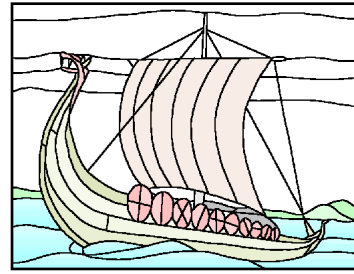

#04-10 VIKING SHIP
© Robert Burrows, Gremlin Glass, Ridgecrest CA

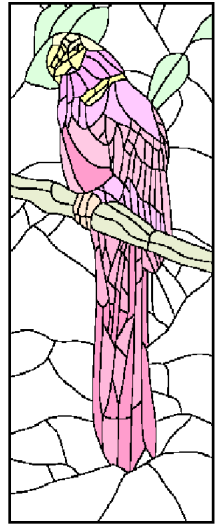

#11-141 SCARLET MACAW
© Paula Zan, Mythling Studio, Hyndman PA

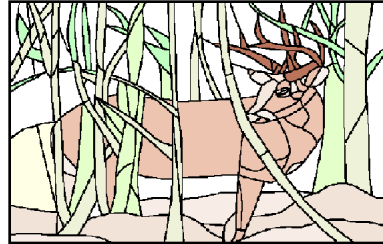

#11-066 CAMOUFLAGED BUCK
© Paula Zan, Mythling Studio, Hyndman PA

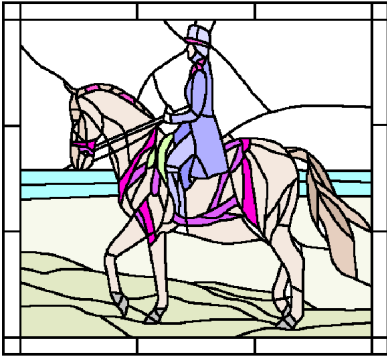

#11-072 DRESSAGE 1
© Paula Zan, Mythling Studio, Hyndman PA

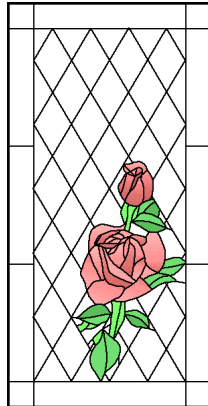

#11-067 TUDOR ROSE
© Paula Zan, Mythling Studio, Hyndman PA

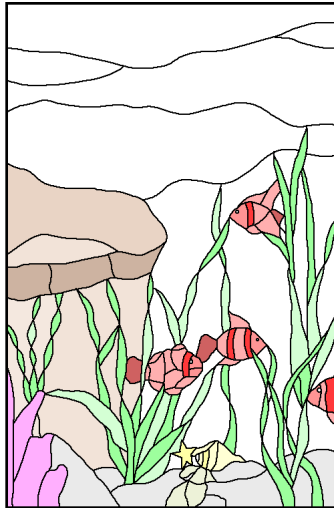

#07-07 UNDERWATER JUNGLE
© Rita Jean Zippo, Magic Glass by Jean, Tamarac FL

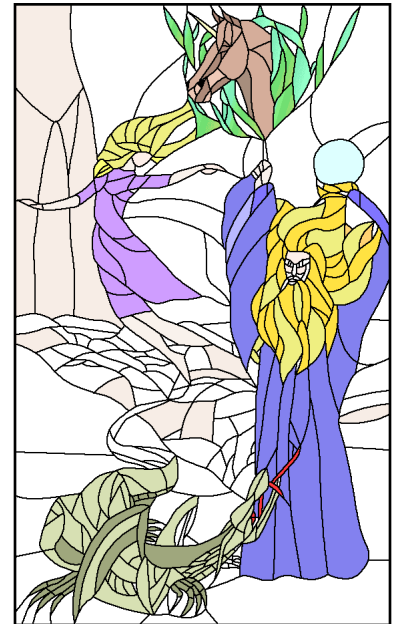

#11-158 MYTHIC SYNERGY
© Paula Zan, Mythling Studio, Hyndman PA

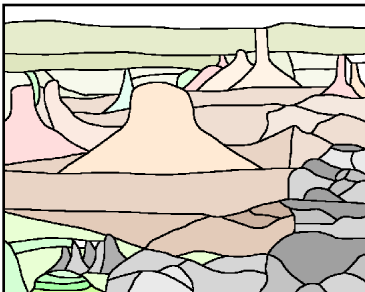

#04-18 MONUMENT VALLEY
© Robert Burrows, Gremlin Glass, Ridgecrest CA

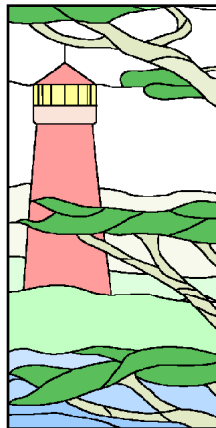

#04-14 MONTEREY LIGHTHOUSE
© Robert Burrows, Gremlin Glass, Ridgecrest CA

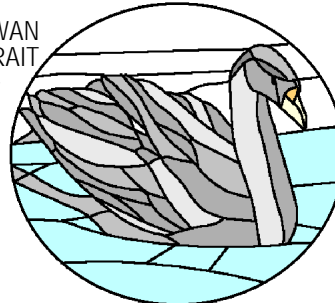

#11-103 SWAN PORTRAIT
© Paula Zan, Mythling Studio, Hyndman PA

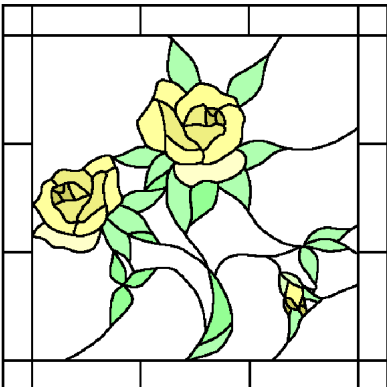

#07-08 BLOOMING ROSES
© Rita Jean Zippo, Magic Glass by Jean, Tamarac FL

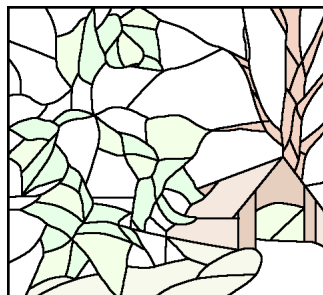

#11-143 AUTUMN GLORY
© Paula Zan, Mythling Studio, Hyndman PA

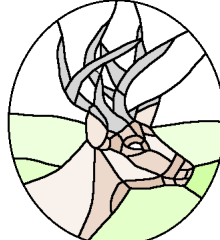

#11-078 WHITE TAIL DEER
© Paula Zan, Mythling Studio, Hyndman PA

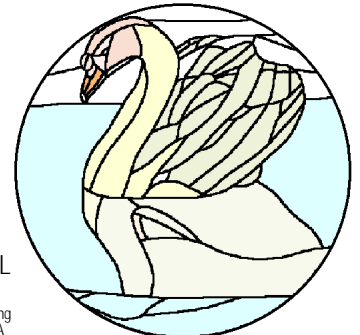

#11-159 SWAN WITH REFLECTION ON WATER
© Paula Zan, Mythling Studio, Hyndman PA

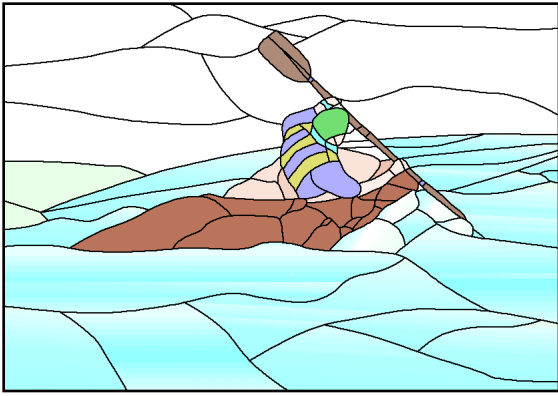

#11-170 KAYAK & WHITE WATER
© Paula Zan, Mything Studio, Hyndman PA

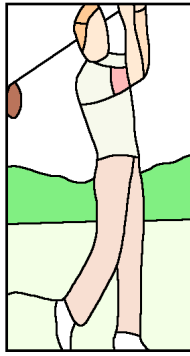

#24-45 MALE GOLFER
© Alex Spatz, Cliffside Studio, East Stroudsburg PA

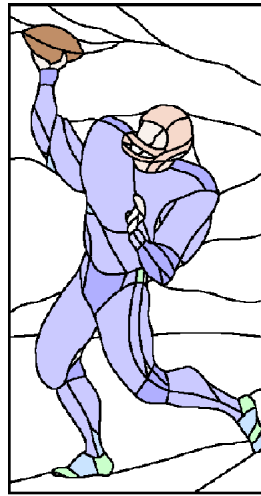

#25-605 FOOTBALL QUARTERBACK
© Aurora Publications, Cal Studio, San Jose CA

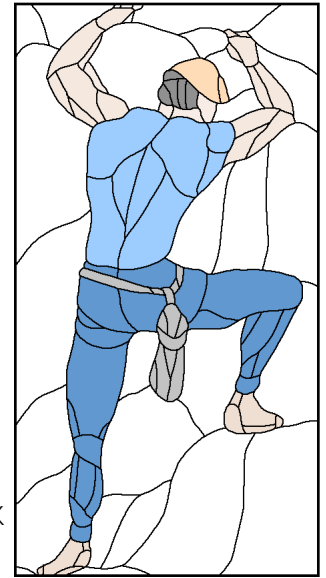

#25-607 ROCK CLIMBER
© Aurora Publications, Cal Studio, San Jose CA

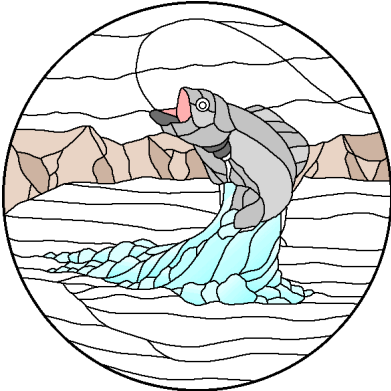

#25-504 FISH JUMPING
© Aurora Publications, Cal Studio, San Jose CA

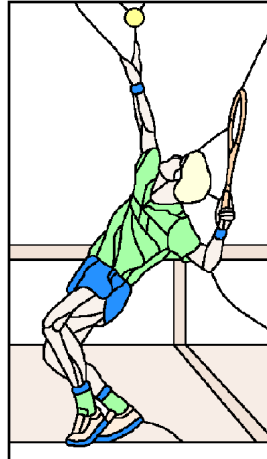

#25-656 TENNIS PLAYER
© Aurora Publications, Cal Studio, San Jose CA

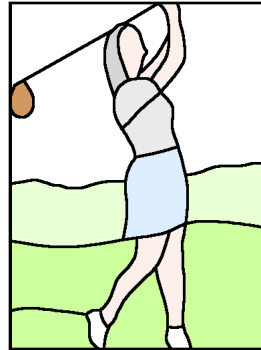

#24-44 FEMALE GOLFER
© Alex Spatz, Cliffside Studio, East Stroudsburg PA

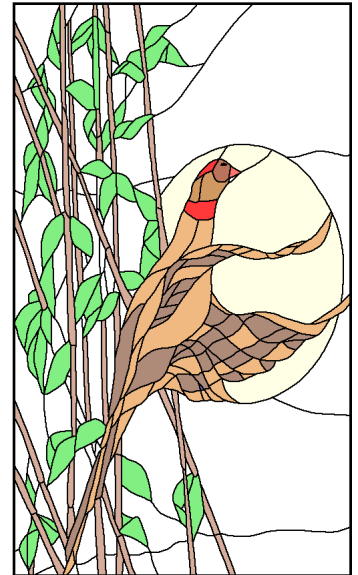

#25-586 PHEASANT FLYING
© Aurora Publications, Cal Studio, San Jose CA



#25-583 MALLARD FLYING
© Aurora Publications, Cal Studio, San Jose CA

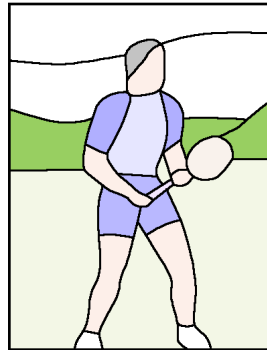

#24-56 MALE TENNIS PLAYER
© Alex Spatz, Cliffside Studio, East Stroudsburg PA

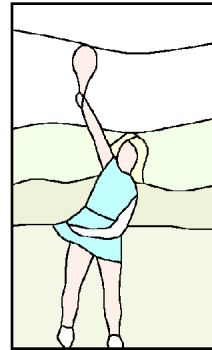

#24-57 FEMALE TENNIS PLAYER
© Alex Spatz, Cliffside Studio, East Stroudsburg PA

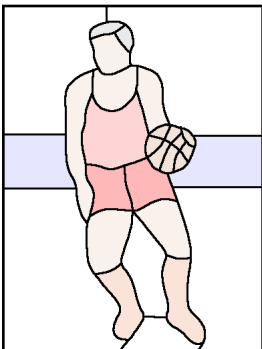

#24-63 BOY BASKETBALL PLAYER
© Alex Spatz, Cliffside Studio, East Stroudsburg PA

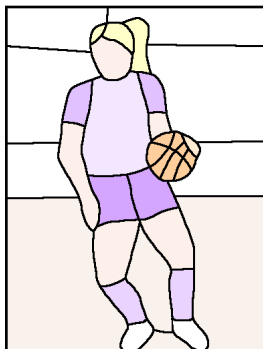

#24-62 GIRL BASKETBALL PLAYER
© Alex Spatz, Cliffside Studio, East Stroudsburg PA

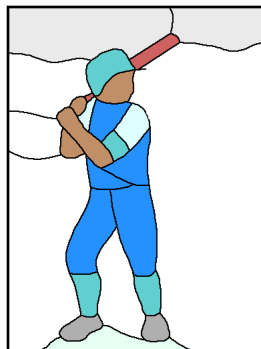

#24-51 BOY BASEBALL PLAYER
© Alex Spatz, Cliffside Studio, East Stroudsburg PA

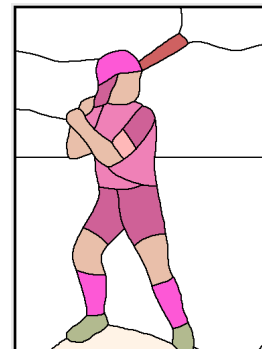

#24-50 GIRL SOFTBALL PLAYER
© Alex Spatz, Cliffside Studio, East Stroudsburg PA

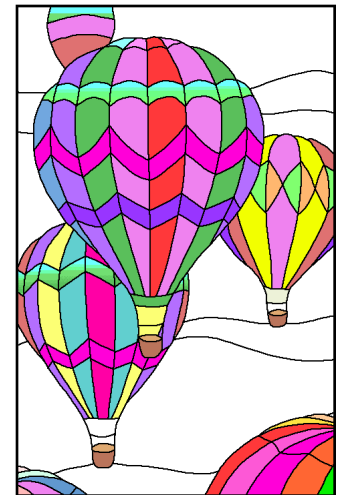

#25-665 HOT AIR BALLOONS
© Aurora Publications, Cal Studio, San Jose CA

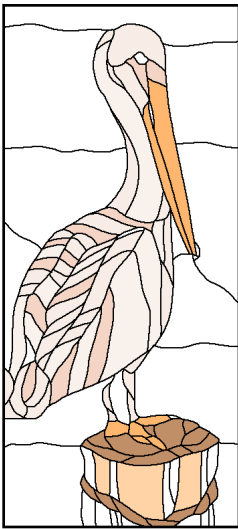

#25-498 PELICAN ON POST
© Aurora Publications, Cal Studio, San Jose CA

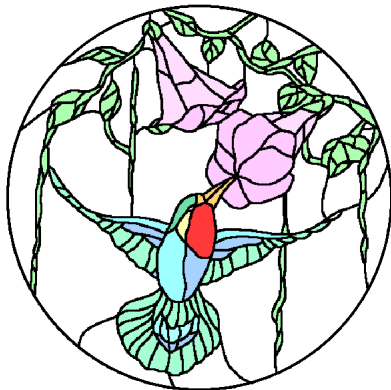

#25-492 HUMMINGBIRD & MORNING GLORIES
© Aurora Publications, Cal Studio, San Jose CA



#25-493 TOUCAN IN JUNGLE
© Aurora Publications, Cal Studio, San Jose CA

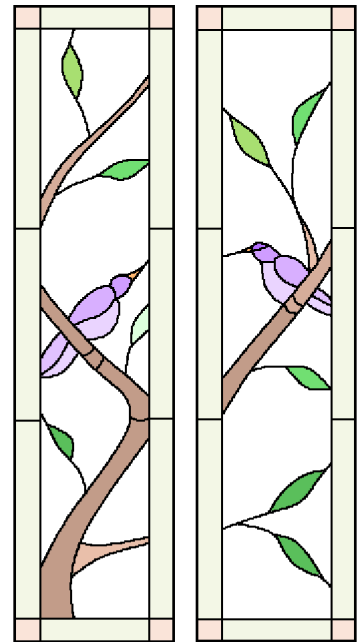

#20-02 BIRDS ON BRANCH (SET OF 2)
© Margaret Cantrell, Detail & Design, Farmland IN

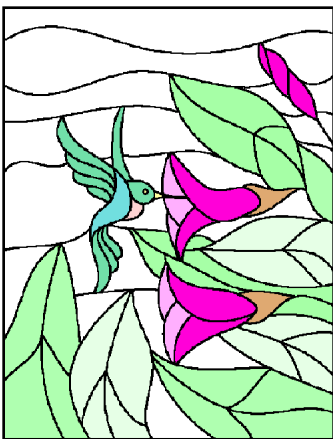

#20-93 HUMMINGBIRD
© Margaret Cantrell, Detail & Design, Farmland IN

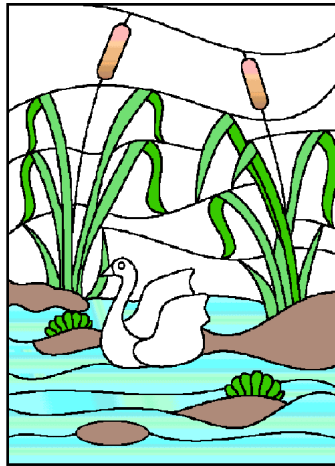

#20-96 SWAN
© Margaret Cantrell, Detail & Design, Farmland IN



#16-52 TWO PARROTS ON VINE
© Rick Hecht, SGO Designer Glass, St. Louis MO



#21-23 ROOSTER
© Nena Vogl, Designer Glass by SGO, Billings MT

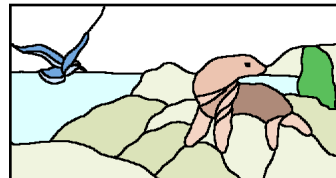

#18-74 SEA LION ON ROCKS
© Rosalie Smith, Coquille OR

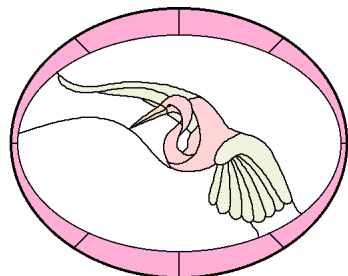

#04-16 EGRET
© Robert Burrows, Gremlin Glass, Ridgecrest CA

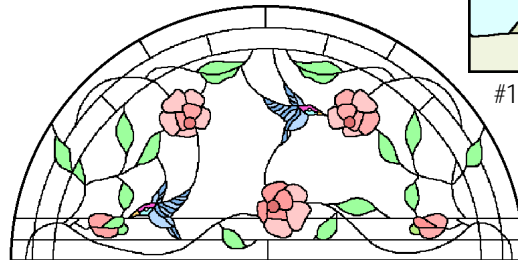

#16-60 1/2 ROUND WITH HUMMINGBIRD
© Rick Hecht, SGO Designer Glass, St. Louis MO

#25-494 FLAMINGO COUPLE IN WATER
© Aurora Publications, Cal Studio, San Jose CA

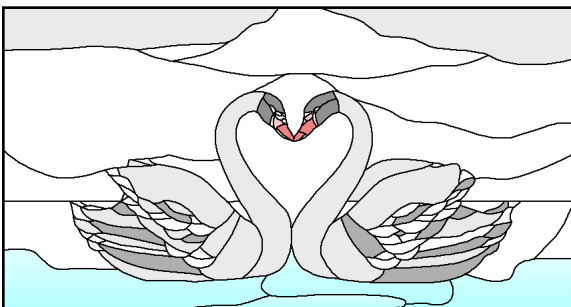
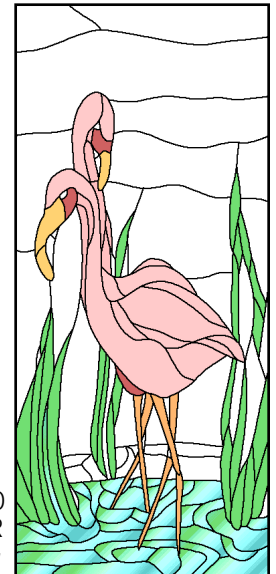

#13-03 PERFECT UNION
© Barbara Williamson, Pane In The Glass Inc, Ft. Lauderdale FL

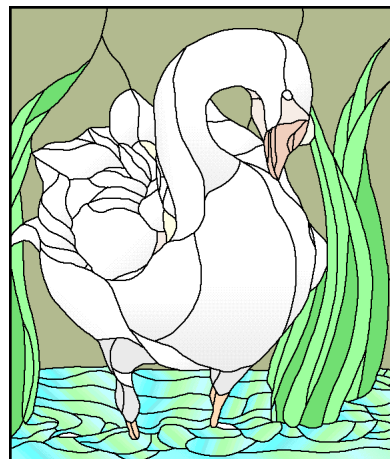

#25-497 SWAN STANDING IN A POND
© Aurora Publications, Cal Studio, San Jose CA

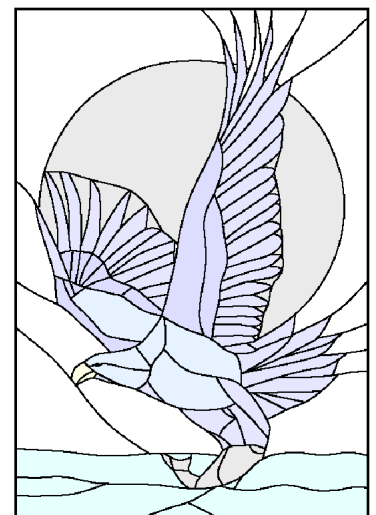

#11-163 CATCH OF THE DAY
© Paula Zan, Mything Studio, Hyndman PA

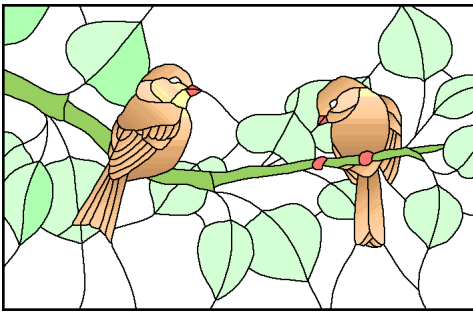

#25-625 CHICKADEES ON ASPEN BRANCH
© Aurora Publications, Cal Studio, San Jose CA

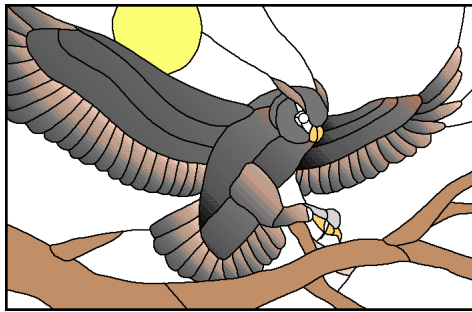

#25-626 NIGHT OWL
© Aurora Publications, Cal Studio, San Jose CA

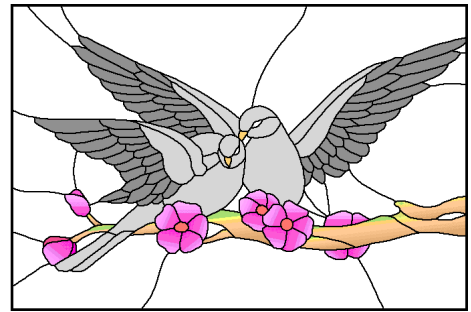

#25-622 DOVES
© Aurora Publications, Cal Studio, San Jose CA

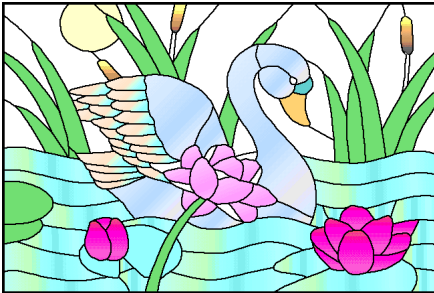

#25-627 SWAN WITH WATER LILIES
© Aurora Publications, Cal Studio, San Jose CA



#25-580 COCKATIEL
© Aurora Publications, Cal Studio, San Jose CA

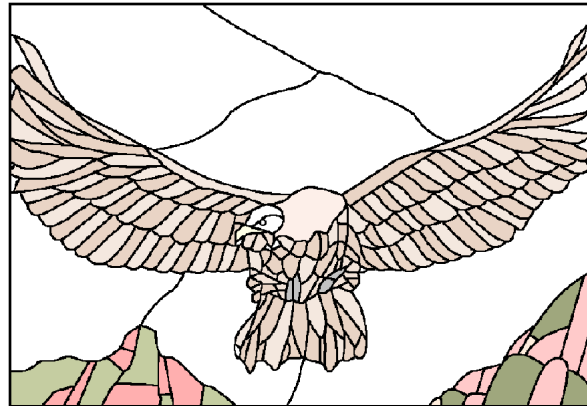

#25-499 EAGLE IN FLIGHT
© Aurora Publications, Cal Studio, San Jose CA

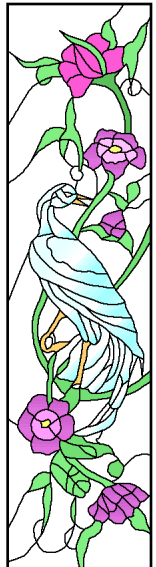

#26-86 HERON
© Susanne Clarke, Scarab Glass Works, Fresno CA

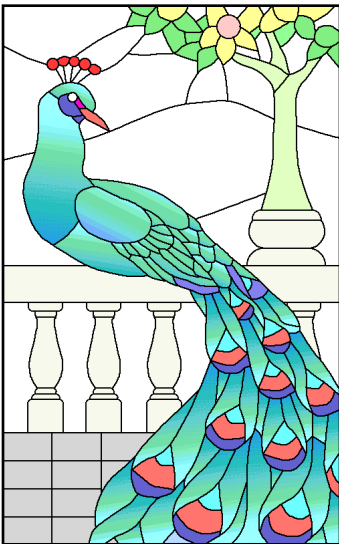

#25-618 PEACOCK
© Aurora Publications, Cal Studio, San Jose CA

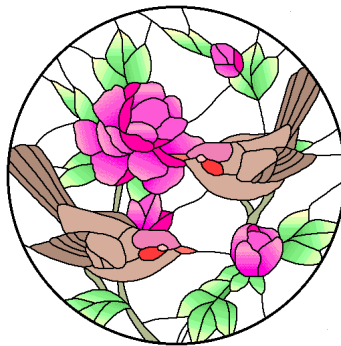

#25-621 BIRDS WITH PEONIES
© Aurora Publications, Cal Studio, San Jose CA

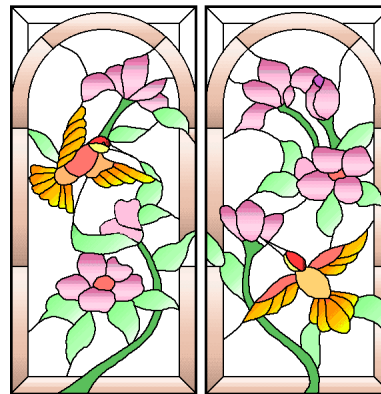

#26-79 HUMMINGBIRD & POSIES (2 PANELS)
© Susanne Clarke, Scarab Glass Works, Fresno CA

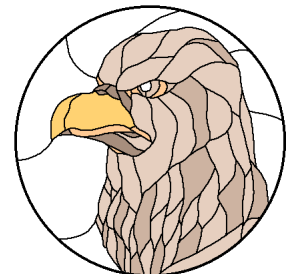

#25-501 EAGLE'S HEAD
© Aurora Publications, Cal Studio, San Jose CA

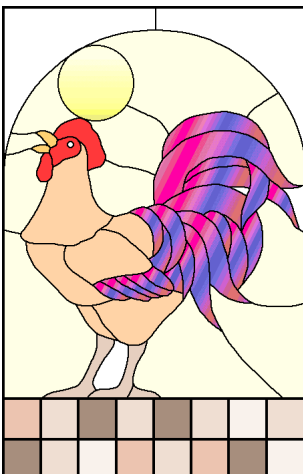

#25-633 ROOSTER
© Aurora Publications, Cal Studio, San Jose CA

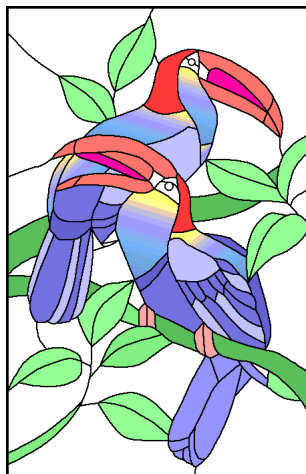

#25-619 TOUCANS
© Aurora Publications, Cal Studio, San Jose CA

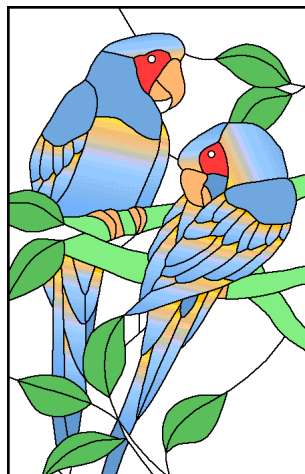

#25-620 MACAWS
© Aurora Publications, Cal Studio, San Jose CA

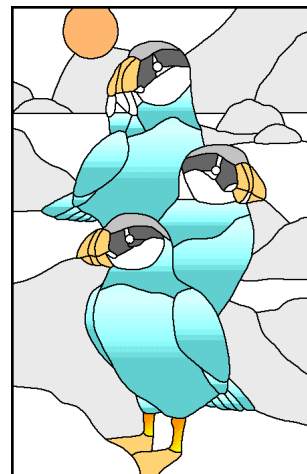

#25-628 PUFFINS
© Aurora Publications, Cal Studio, San Jose CA

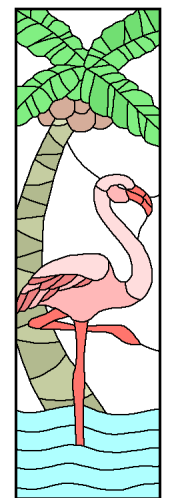

#25-624 FLAMINGO
© Aurora Publications, Cal Studio, San Jose CA

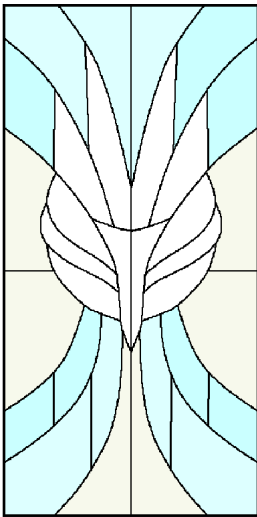

#20-05 DESCENDING DOVE

© Margaret Cantrell, Detail & Design, Farmland IN

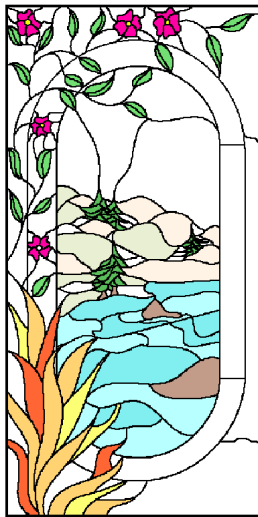

#18-70 RIVER OF LIFE / BURNING BUSH

© Rosalie Smith, Coquille OR

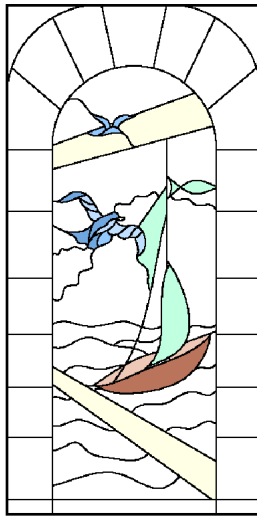

#18-65 FISHERMAN AT SEA

© Rosalie Smith, Coquille OR

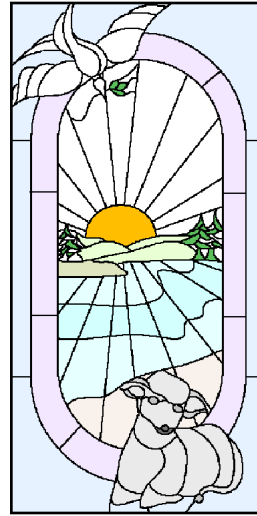

#18-69 TRIAGE RIVER OF LIFE

© Rosalie Smith, Coquille OR

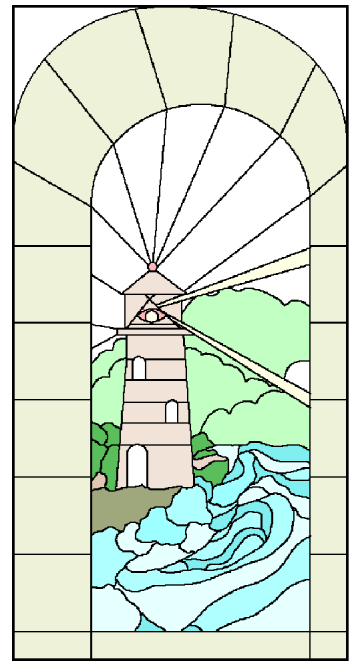

#18-67 EYE OF GOD SHINING THE LIGHT

© Rosalie Smith, Coquille OR

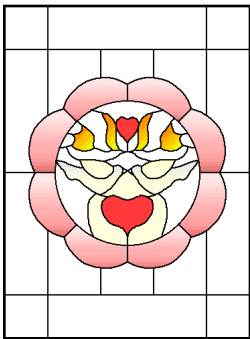

#26-74 LOVEBIRDS

© Susanne Clarke, Scarab Glass Works, Fresno CA

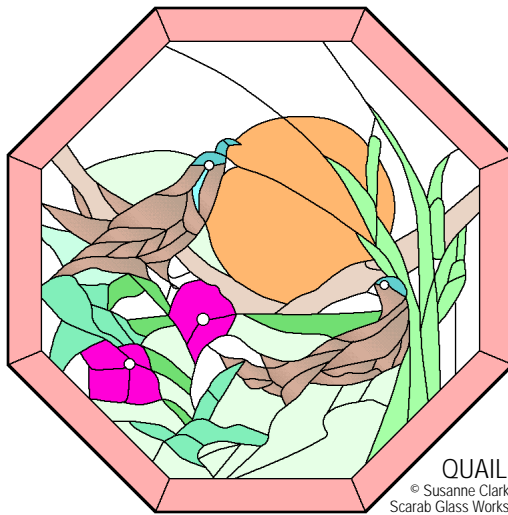

#26-27 QUAIL'S NEST

© Susanne Clarke, Scarab Glass Works, Fresno CA

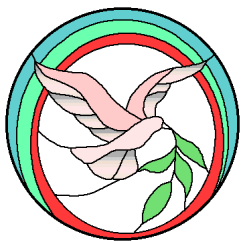

#26-76 DOVE WITH BRANCH

© Susanne Clarke, Scarab Glass Works, Fresno CA

#25-634 GEESE

© Aurora Publications, Cal Studio, San Jose CA

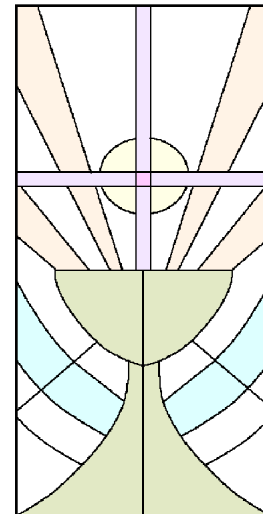
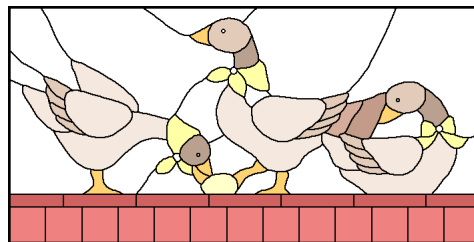

#20-06 CHALLIS & WAFER

© Margaret Cantrell, Detail & Design, Farmland IN

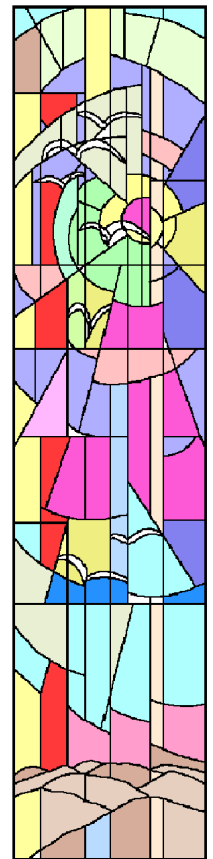

#12-88 MORNING FLIGHT

© Charles F. Ottolini, Ottolini Studios, Sevierville TN

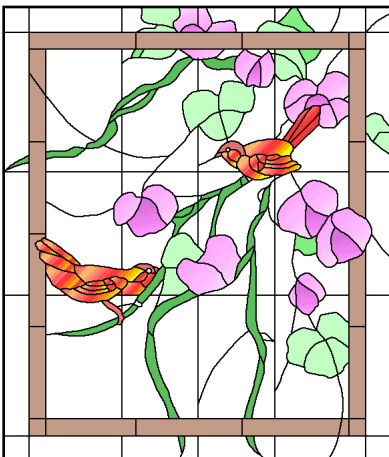

#26-26 BIRDS OF CANTON

© Susanne Clarke, Scarab Glass Works, Fresno CA

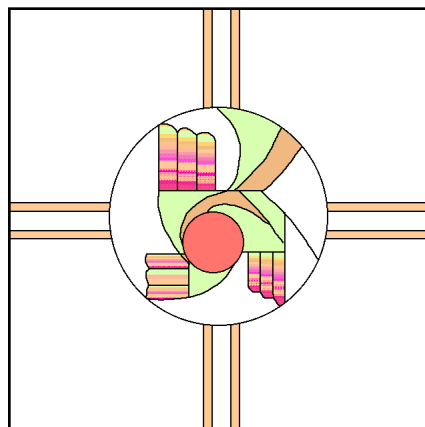

#27-66 PUEBLO RAINBIRD

© Karen Painter, Coloured Vision, Tucson AZ

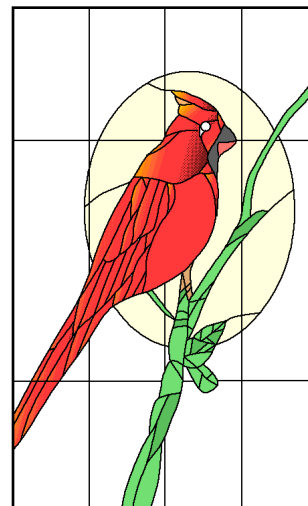

#25-579 NORTHERN CARDINAL

© Aurora Publications, Cal Studio, San Jose CA

You've seen The Dome™

A 46"x12" ceiling steel dome frame that holds 25 separate & flat glass panels. Needs 15" vertical. Light by artificial lights / skylight for dazzling beauty! Patented



Other SupraDome™ Sizes:
69 1/4" • 77 1/2" • 93 1/2" • 123"
SupraDomes are 12-, 16-, or 24-sided frames.

Available from your stained glass dealer!

Sierra Stained Glass Studios Inc.

1153 Yale Ave Modesto CA 95350 209-409-3850 Fax: 529-0632

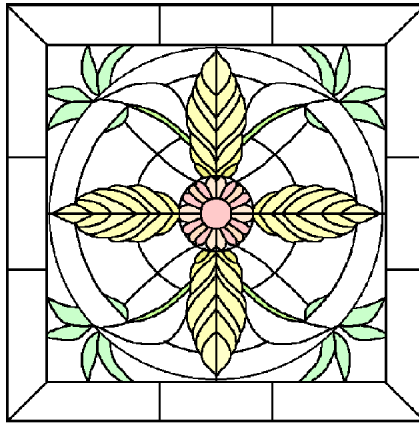

#12-82 GEOMETRIC DOGWOOD
© Charles F. Ottolini, Ottolini Studios, Sevierville TN

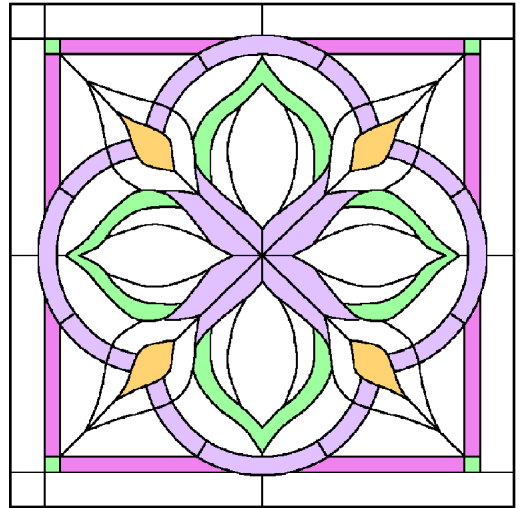

#12-67 KALIEDOSCOPIC FLOWER
© Charles F. Ottolini, Ottolini Studios, Sevierville TN

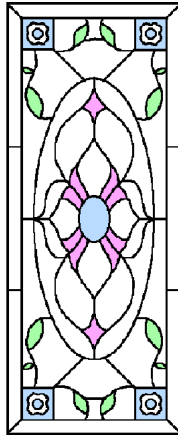

#12-44 OVAL
MEDALLION
WITH
DOGWOOD
CORNERS
© Charles F. Ottolini,
Ottolini Studios,
Sevierville TN

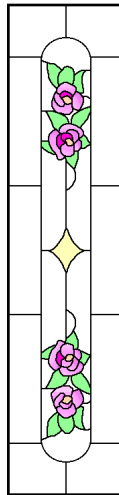

#16-47
FLORAL
SIDELIGHT
© Rick Hecht, SGO
Designer Glass,
St. Louis MO

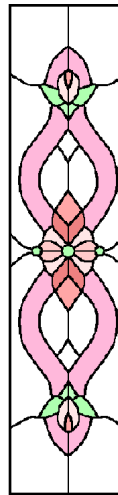

#16-51
GEOMETRIC
SIDELIGHT
© Rick Hecht, SGO
Designer Glass,
St. Louis MO

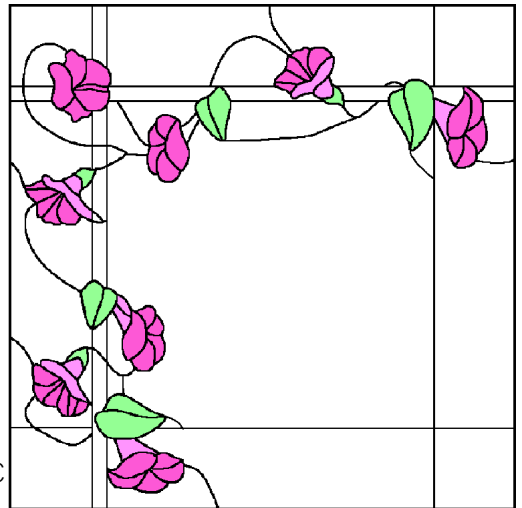

#16-40 TRUMPET VINE ON TRELLIS
© Rick Hecht, SGO Designer Glass, St. Louis MO

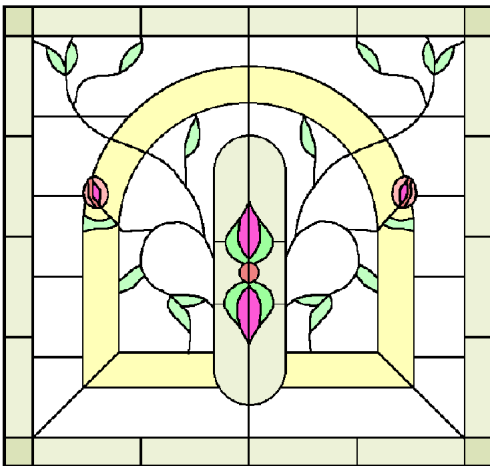

< #12-54
ABSTRACT
FLOWER DESIGN
© Charles F. Ottolini,
Ottolini Studios,
Sevierville TN

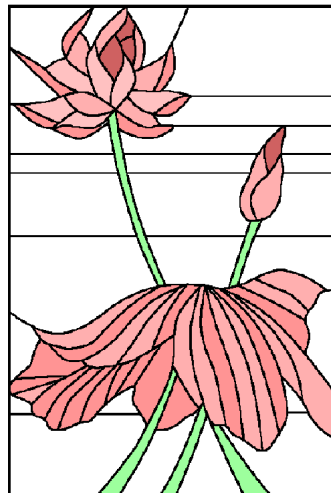

#12-99 LOTUS
© Charles F. Ottolini, Ottolini Studios, Sevierville TN

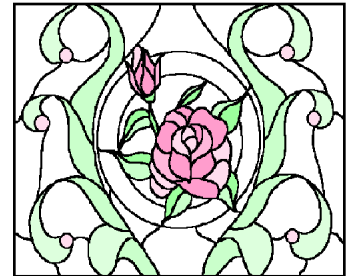

#18-75
VICTORIAN
ROSE
© Rosalie Smith,
Coquille OR

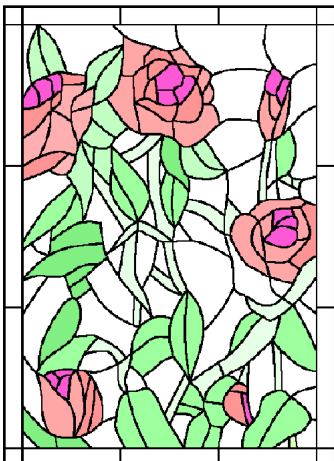

#16-39 >
LILY
SIDELIGHT
© Rick Hecht, SGO
Designer Glass, St.
Louis MO

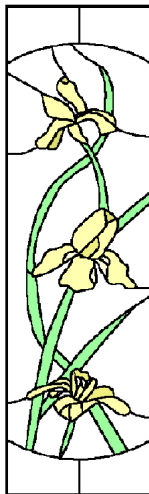

< #11-100
ROSE
WINDOW
© Paula Zan, Mythling
Studio, Hyndman PA

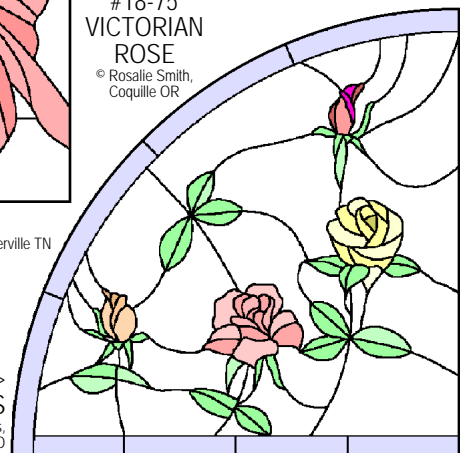

#16-48 >
1/4 ROUND WITH ROSES
© Rick Hecht, SGO Designer Glass,
St. Louis MO

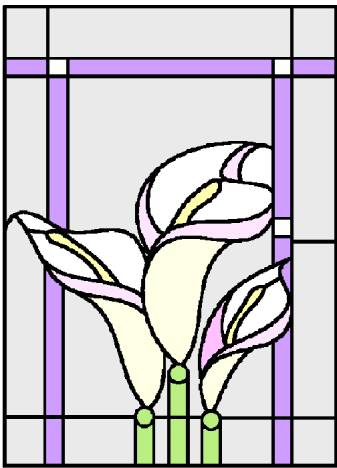

#20-94 CALLA LILIES

© Margaret Cantrell, Detail & Design, Farmland IN

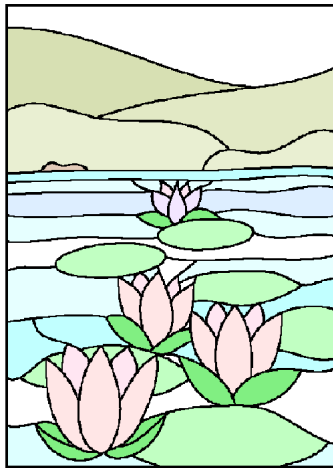

#20-95 LILY PADS

© Margaret Cantrell, Detail & Design, Farmland IN

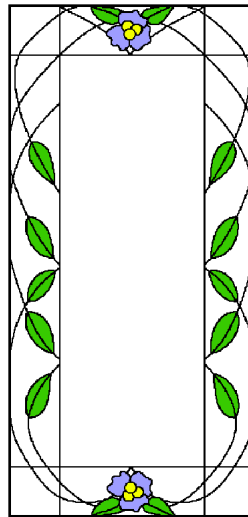

#20-97 PRAIRIE DOOR FLOWERS

© Margaret Cantrell, Detail & Design, Farmland IN

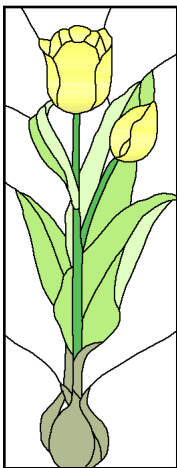

#25-653

TULIP BULB

© Aurora Publications, Cal Studio, San Jose CA

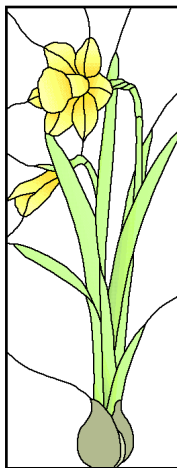

#25-654

DAFFODIL BULB

© Aurora Publications, Cal Studio, San Jose CA

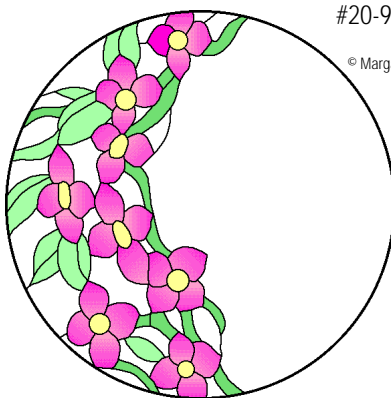

#25-573 ASIAN DOGWOOD MIRROR

© Aurora Publications, Cal Studio, San Jose CA

#25-652 (below) BUTTERFLIES & ROSES

© Aurora Publications, Cal Studio, San Jose CA

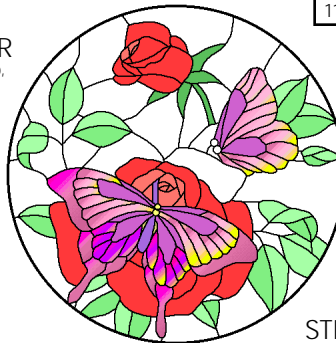

#26-30 > STRAWBERRY

© Susanne Clarke, Scarab Glass Works, Fresno CA

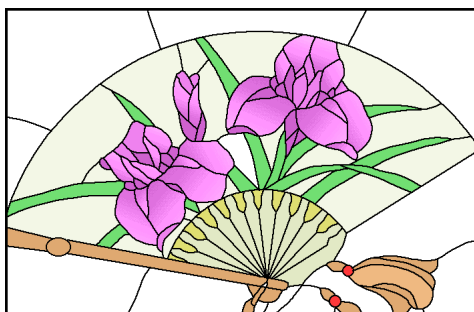
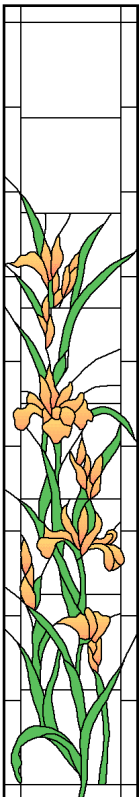
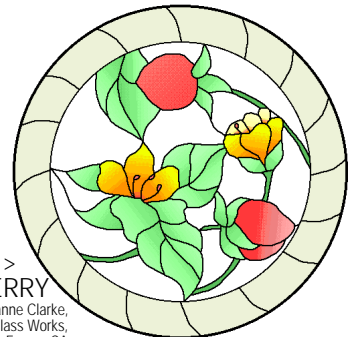

#25-614 IRIS FAN

© Aurora Publications, Cal Studio, San Jose CA

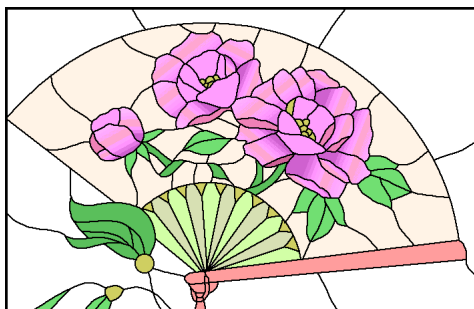

#25-613 PEONY FAN

© Aurora Publications, Cal Studio, San Jose CA

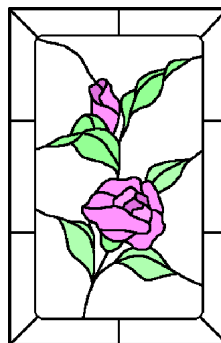

#21-24 ROSE

© Nena Vogl, Designer Glass by SGO, Billings MT

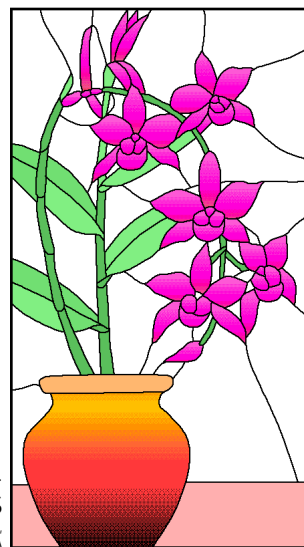

#25-655 > ORCHIDS

© Aurora Publications, Cal Studio, San Jose CA

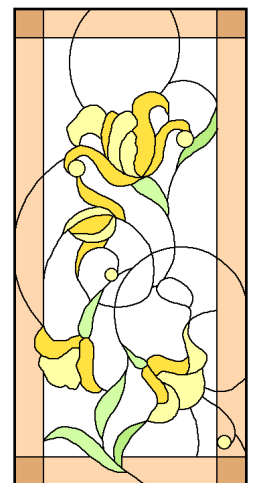

#26-75

CHINA PATTERN

© Susanne Clarke, Scarab Glass Works, Fresno CA

...Now we've turned things upside down!



The Dome... Inverted!™

A 48"x12" octagonal inverted steel dome frame that holds 25 separate & flat glass panels. Bolts to the ceiling. Includes 4 full-sized patterns and wood trim!

Available from your stained glass dealer!

Sierra Stained Glass Studios Inc.

1153 Yale Ave Modesto CA 95350 209-409-3850 Fax: 529-0632

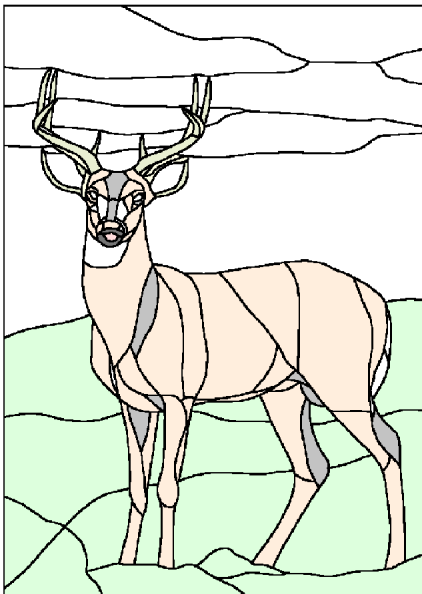

#11-231 WHITETAIL DEER
© Paula Zan, Mything Studio, Hyndman PA



#26-88 EASTERN FLARE
© Susanne Clarke, Scarab Glass Works, Fresno CA

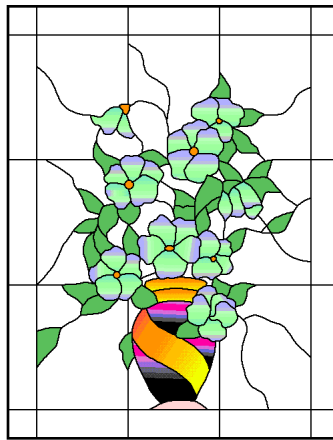

#26-83 PANSIES
© Susanne Clarke, Scarab Glass Works, Fresno CA

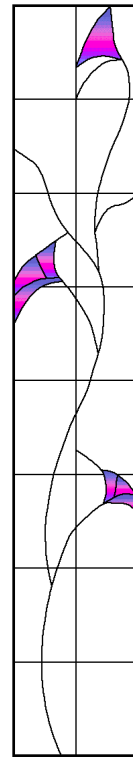

#27-65 STYLIZED FLORAL
© Karen Painter, Coloured Vision, Tucson AZ

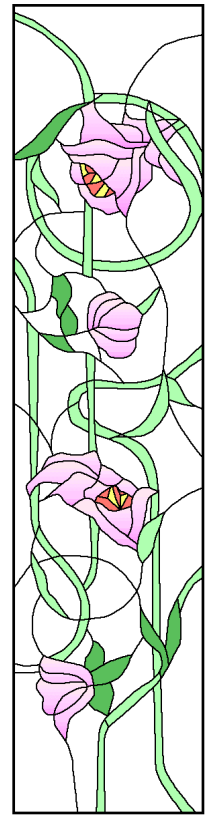

#26-91 STYLIZED FLORAL
© Susanne Clarke, Scarab Glass Works, Fresno CA

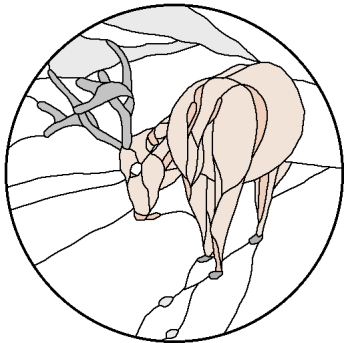

#25-589 ELK FORAGING
© Aurora Publications, Cal Studio, San Jose CA

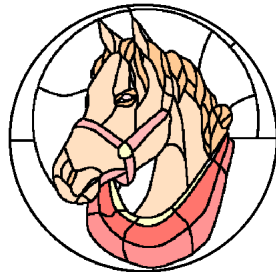

#25-508 HORSE'S HEAD
© Aurora Publications, Cal Studio, San Jose CA

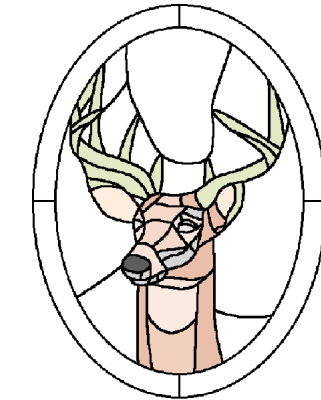

#11-168 PORTRAIT OF A BUCK
© Paula Zan, Mything Studio, Hyndman PA

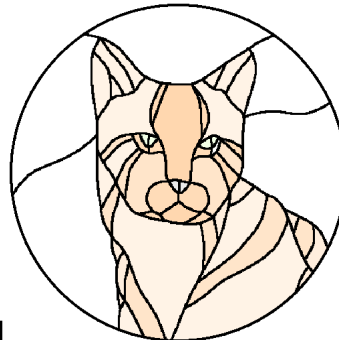

#25-597 HOUSE CAT
© Aurora Publications, Cal Studio, San Jose CA

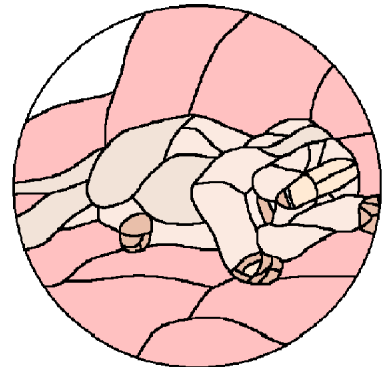

#11-238 ALL PLAYED OUT
© Paula Zan, Mything Studio, Hyndman PA

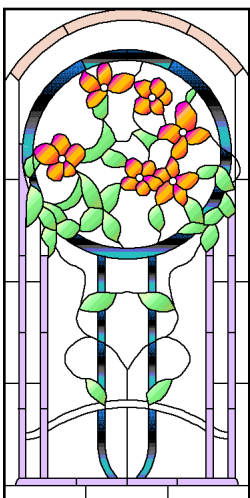

#26-84 ANTIQUE FLORAL
© Susanne Clarke, Scarab Glass Works, Fresno CA

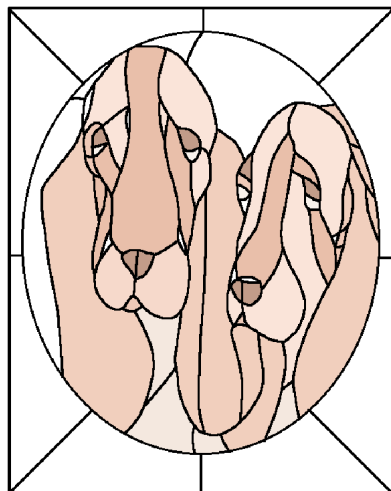

#25-595 HOUND DOGS
© Aurora Publications, Cal Studio, San Jose CA

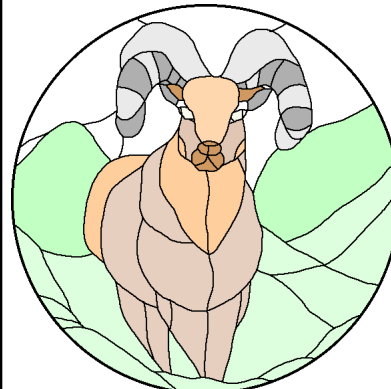

#25-587 BIGHORN SHEEP
© Aurora Publications, Cal Studio, San Jose CA

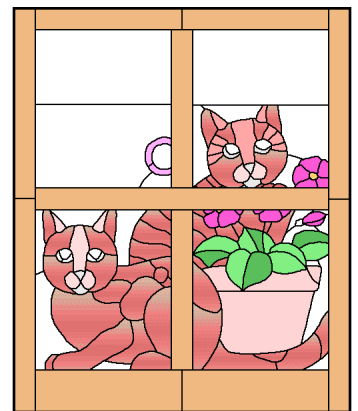

#25-631 WINDOW CATS
© Aurora Publications, Cal Studio, San Jose CA

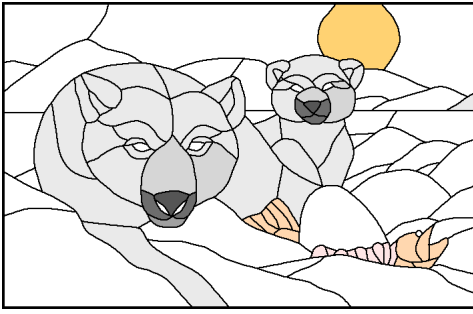

#25-629 POLAR BEAR

© Aurora Publications, Cal Studio, San Jose CA

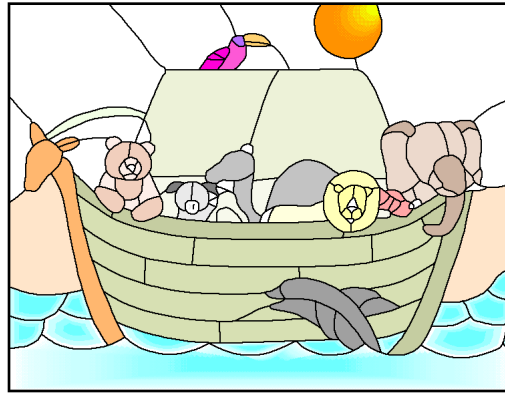

#25-638 NOAH'S ARK

© Aurora Publications, Cal Studio, San Jose CA

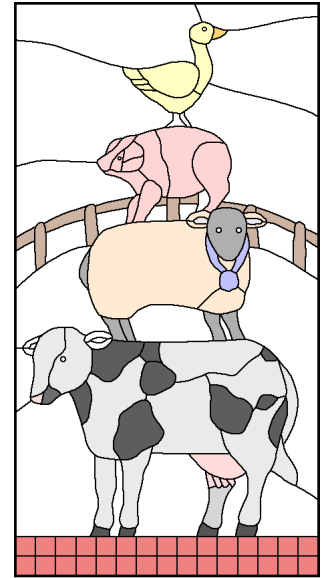

#25-636 COUNTRY ANIMALS

© Aurora Publications, Cal Studio, San Jose CA

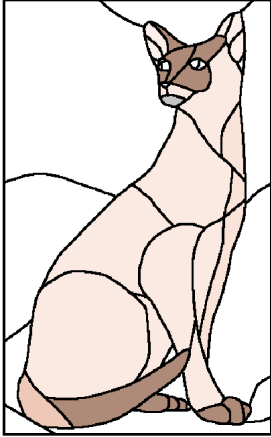

#25-599 SIAMESE CAT

© Aurora Publications, Cal Studio, San Jose CA

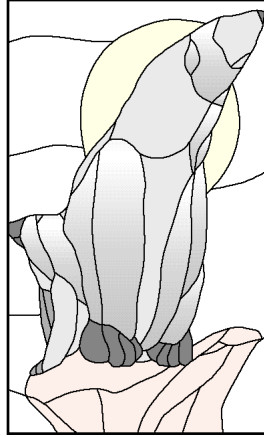

#25-591 POLAR BEAR

© Aurora Publications, Cal Studio, San Jose CA

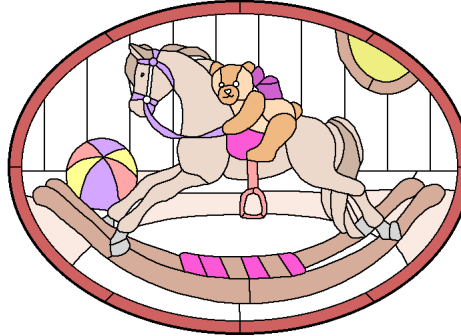

#25-637 ROCKING HORSE & TEDDY BEAR

© Aurora Publications, Cal Studio, San Jose CA

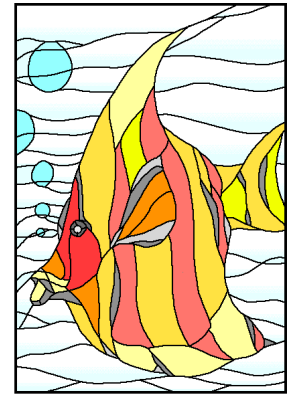

#25-603 TROPICAL FISH

© Aurora Publications, Cal Studio, San Jose CA

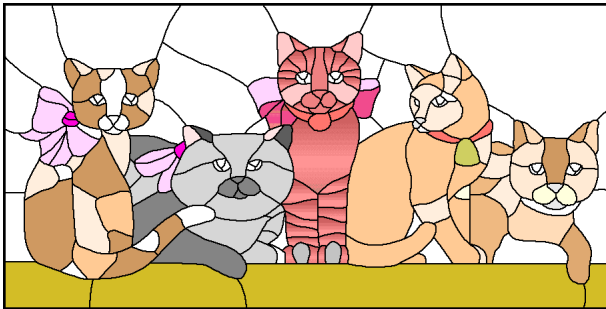

#25-632 CAT QUINTET

© Aurora Publications, Cal Studio, San Jose CA

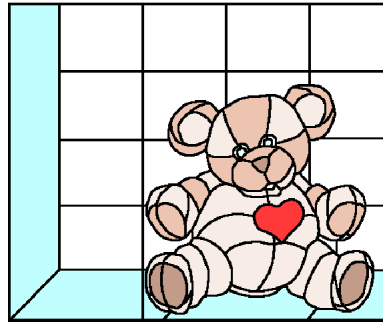

#15-32 TEDDY IN WINDOW

© Hilary A. Bobker, Sky Lights, Drexel Hill PA

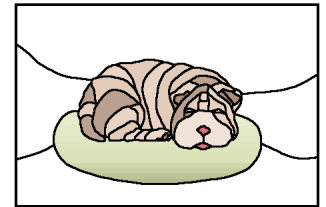

#23-35 SHAR-PEI PUPPY

© Deborah Leary, The Lighthouse Stained Glass Studio, Rochester NH

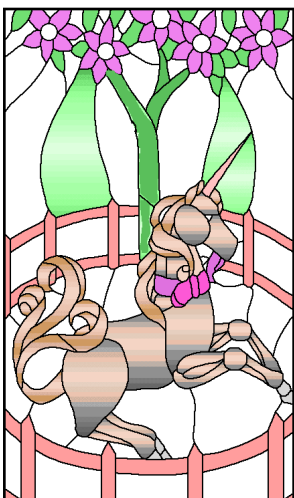

#25-664 UNICORN GARDEN

© Aurora Publications, Cal Studio, San Jose CA

#23-70 PERSIAN CAT LAMP [3-PANELS]
© Deborah Leary, The Lighthouse Stained Glass Studio, Rochester NH

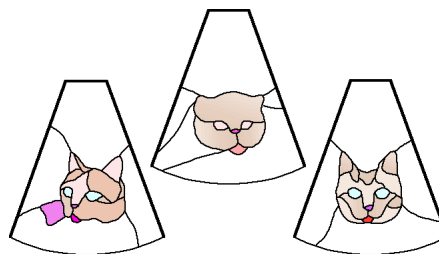

#11-888 LOVE BIRDS LAMP PANEL (4 PANEL LAMP)
© Paula Zan, Mythling Studio, Hyndman PA

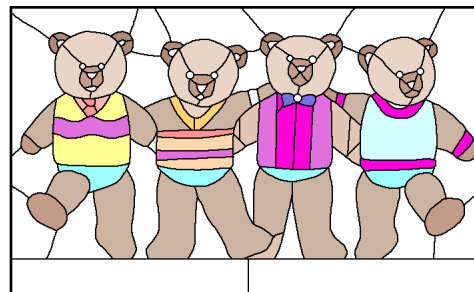

#25-641 TEDDY BEARS

© Aurora Publications, Cal Studio, San Jose CA



#25-630 TIGER

© Aurora Publications, Cal Studio, San Jose CA

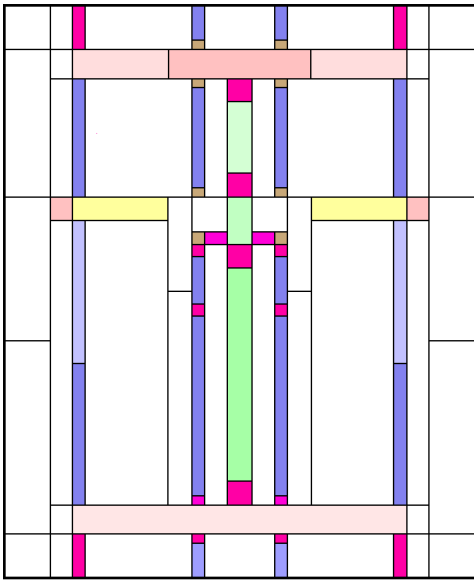

#24-78 PRAIRIE DESIGNS, PG. 1
© Alex Spatz, Cliffside Studio, East Stroudsburg PA

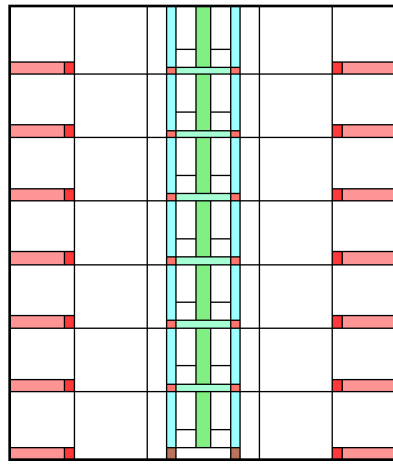

#24-84 PRAIRIE DESIGNS, PG. 6
© Alex Spatz, Cliffside Studio, East Stroudsburg PA

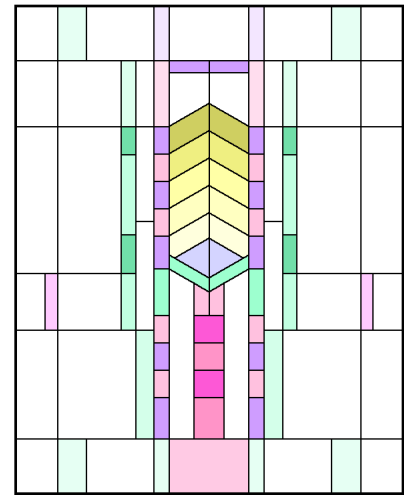

#24-83 PRAIRIE DESIGNS, PG. 5A
© Alex Spatz, Cliffside Studio, East Stroudsburg PA

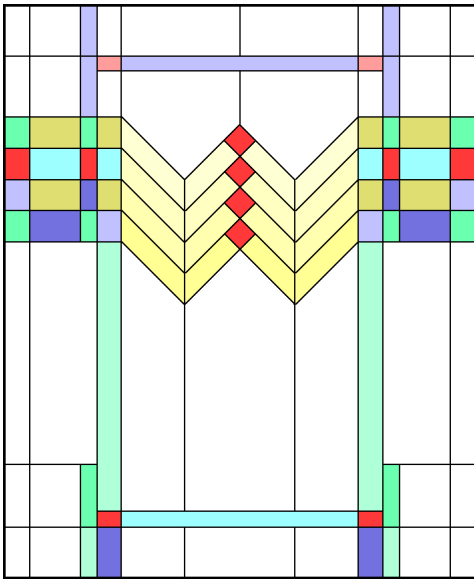

#24-79 PRAIRIE DESIGNS, PG. 2
© Alex Spatz, Cliffside Studio, East Stroudsburg PA

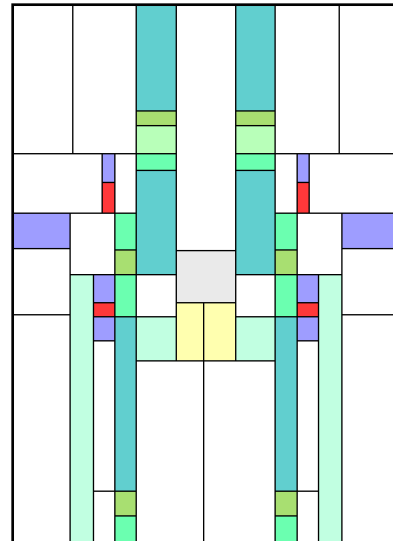

#24-90 PRAIRIE DESIGNS, PG. 11C
© Alex Spatz, Cliffside Studio, East Stroudsburg PA

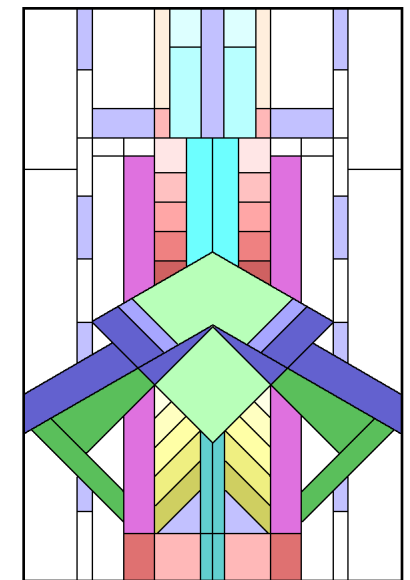

#24-88 PRAIRIE DESIGNS, PG. 9A
© Alex Spatz, Cliffside Studio, East Stroudsburg PA

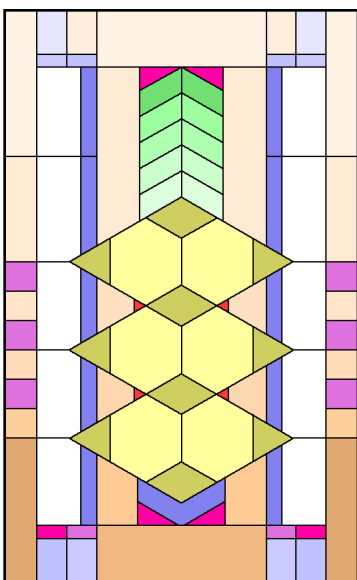

#24-87 PRAIRIE DESIGNS, PG. 9B
© Alex Spatz, Cliffside Studio, East Stroudsburg PA

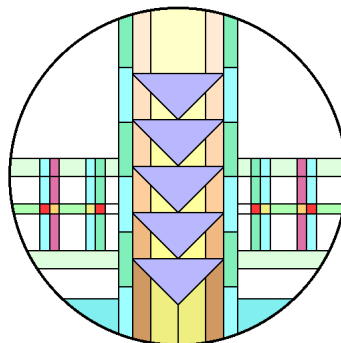

#24-80 PRAIRIE DESIGNS, PG. 4
© Alex Spatz, Cliffside Studio, East Stroudsburg PA

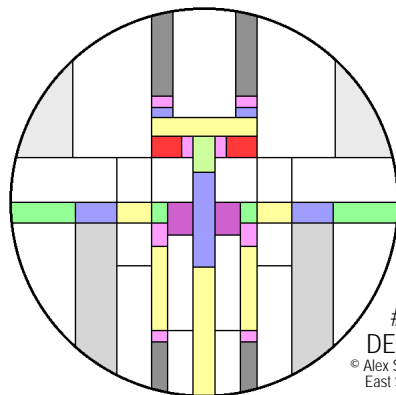

#24-86 PRAIRIE DESIGNS, PG. 8
© Alex Spatz, Cliffside Studio, East Stroudsburg PA

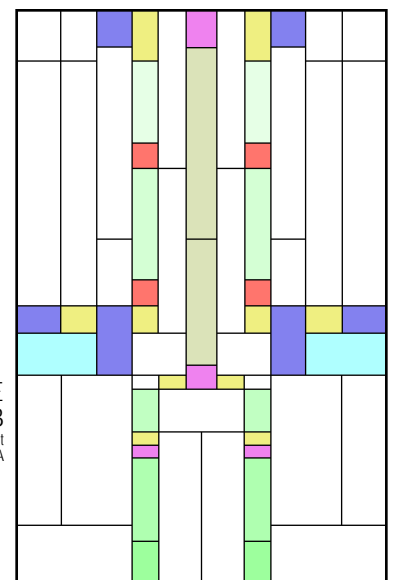

#24-82 PRAIRIE DESIGNS, PG. 5B
© Alex Spatz, Cliffside Studio, East Stroudsburg PA

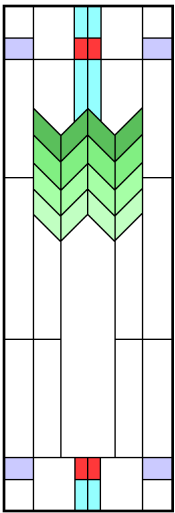

#24-92 PRAIRIE DESIGNS, PG. 11A
© Alex Spatz, Cliffside Studio, East Stroudsburg PA

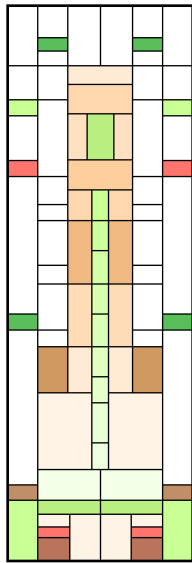

#24-18 PRAIRIE DESIGNS, PG. 31B
© Alex Spatz, Cliffside Studio, East Stroudsburg PA

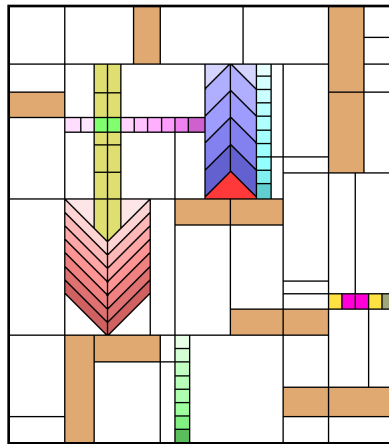

#24-97 PRAIRIE DESIGNS, PG. 15A
© Alex Spatz, Cliffside Studio, East Stroudsburg PA

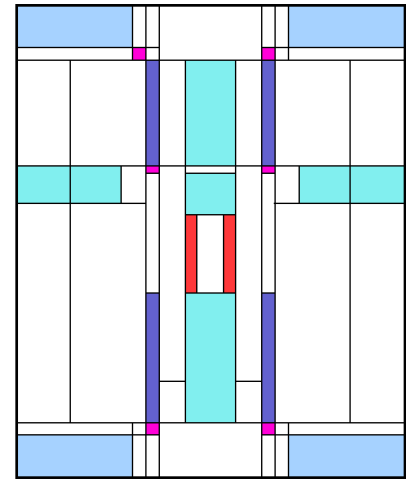

#24-95 PRAIRIE DESIGNS, PG. 14
© Alex Spatz, Cliffside Studio, East Stroudsburg PA

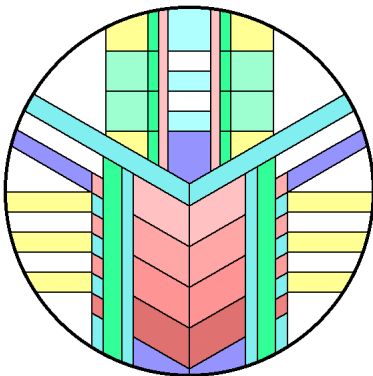

#24-99 PRAIRIE DESIGNS, PG. 17
© Alex Spatz, Cliffside Studio, East Stroudsburg PA

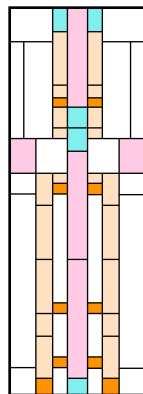

#24-19 PRAIRIE DESIGNS, PG. 31A
© Alex Spatz, Cliffside Studio, East Stroudsburg PA

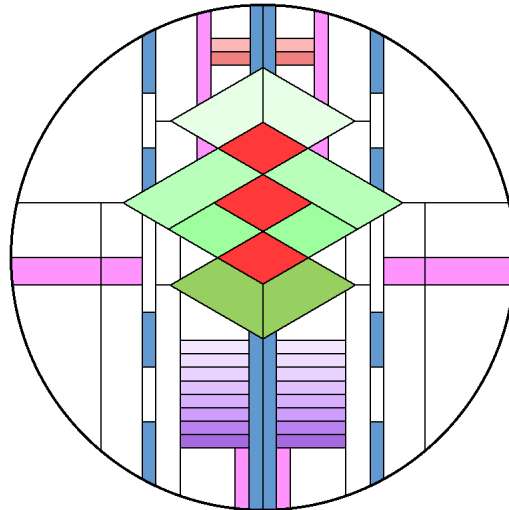

#24-94 PRAIRIE DESIGNS, PG. 13
© Alex Spatz, Cliffside Studio, East Stroudsburg PA

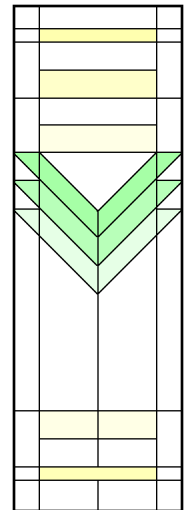

#24-91 PRAIRIE DESIGNS, PG. 11B
© Alex Spatz, Cliffside Studio, East Stroudsburg PA

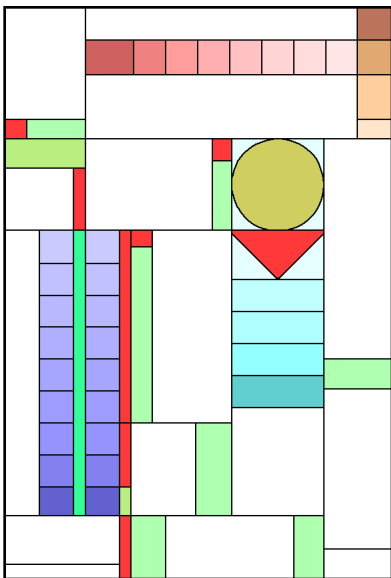

#24-96 PRAIRIE DESIGNS, PG. 15B
© Alex Spatz, Cliffside Studio, East Stroudsburg PA

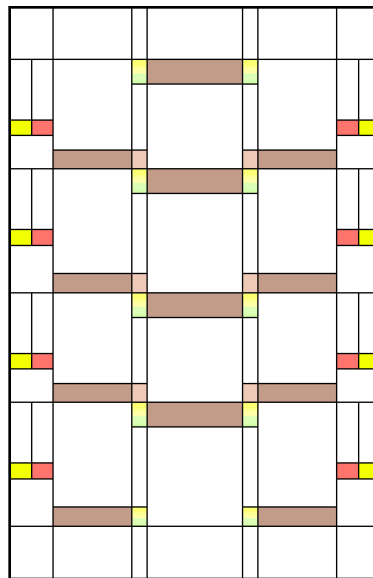

#24-02 PRAIRIE DESIGNS, PG. 20B
© Alex Spatz, Cliffside Studio, East Stroudsburg PA

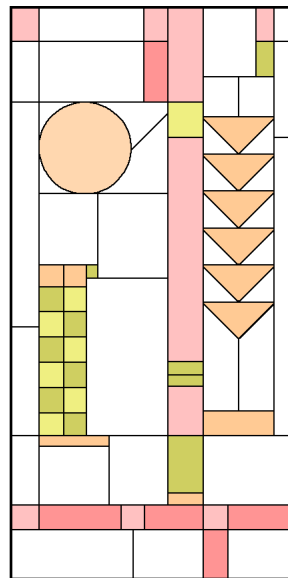

#24-01 PRAIRIE DESIGNS, PG. 19
© Alex Spatz, Cliffside Studio, East Stroudsburg PA

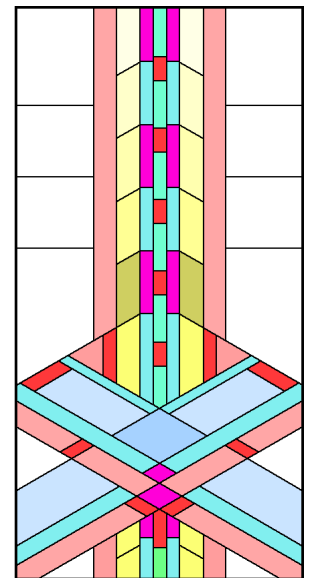

#24-98 PRAIRIE DESIGNS, PG. 16
© Alex Spatz, Cliffside Studio, East Stroudsburg PA

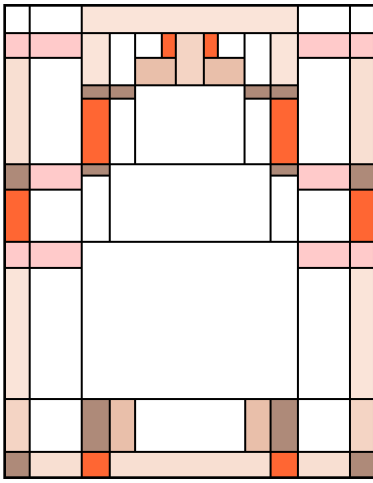

#24-14 PRAIRIE DESIGNS,
PG. 28A
© Alex Spatz, Cliffside Studio, East Stroudsburg PA

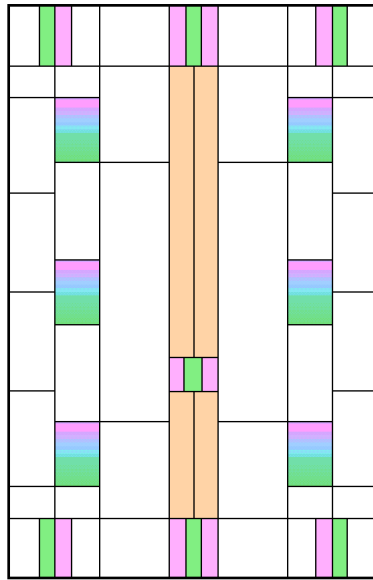

#24-03 PRAIRIE DESIGNS, PG. 20A
© Alex Spatz, Cliffside Studio, East Stroudsburg PA

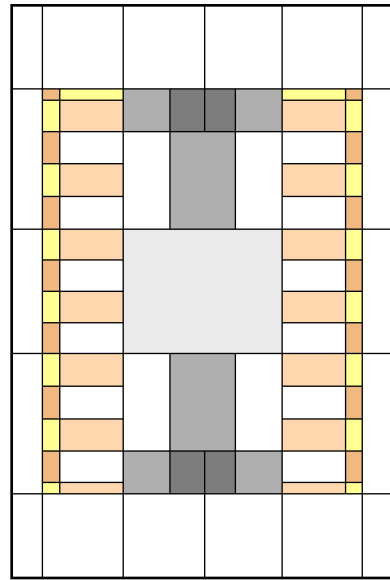

#24-13 PRAIRIE DESIGNS, PG. 25B
© Alex Spatz, Cliffside Studio, East Stroudsburg PA

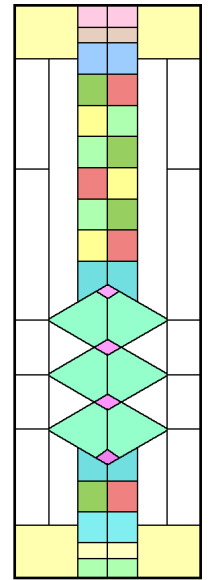

#24-07 PRAIRIE
DESIGNS, PG. 23B
© Alex Spatz, Cliffside Studio,
East Stroudsburg PA

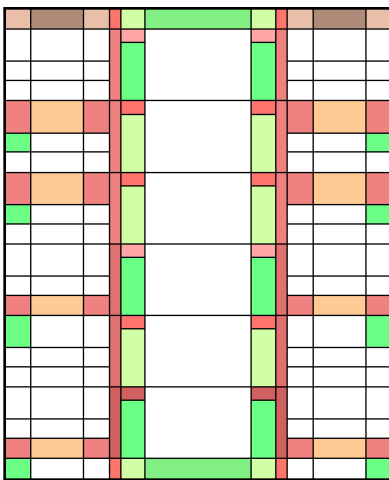

#24-09 PRAIRIE
DESIGNS, PG. 24
© Alex Spatz, Cliffside Studio,
East Stroudsburg PA

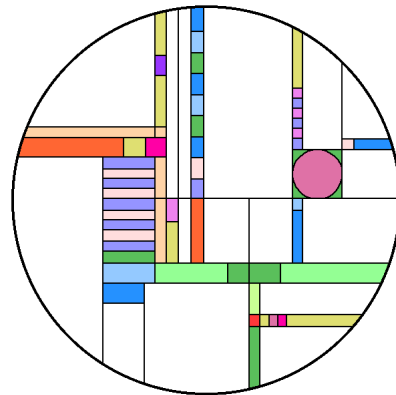

#24-05 PRAIRIE
DESIGNS, PG. 22
© Alex Spatz, Cliffside Studio,
East Stroudsburg PA

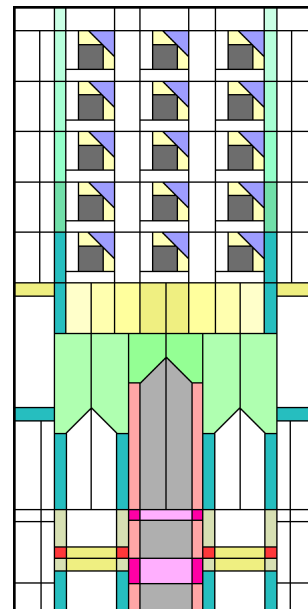

#24-12 PRAIRIE DESIGNS,
PG. 27
© Alex Spatz, Cliffside Studio, East Stroudsburg PA

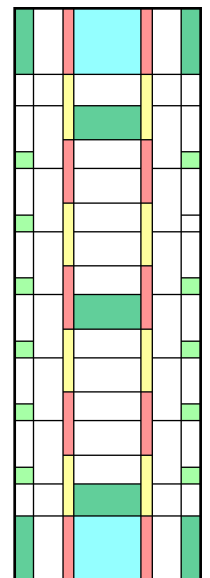

#24-08 PRAIRIE
DESIGNS PG. 23A
© Alex Spatz, Cliffside Studio,
East Stroudsburg PA

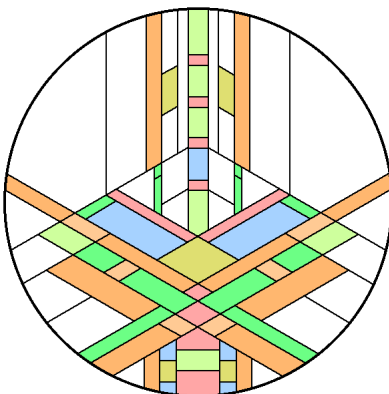

#24-04 PRAIRIE
DESIGNS,
PG. 21
© Alex Spatz, Cliffside Studio,
East Stroudsburg PA

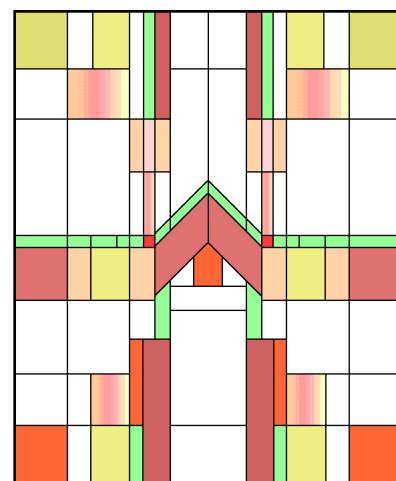

#24-06 PRAIRIE DESIGNS, PG. 23C
© Alex Spatz, Cliffside Studio, East Stroudsburg PA

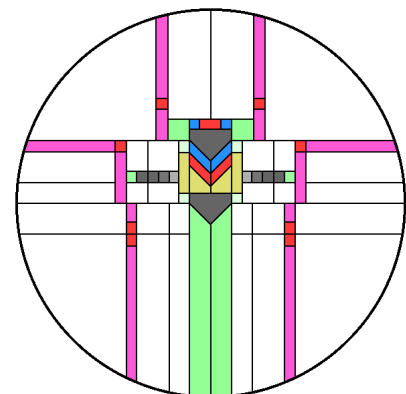

#24-10 PRAIRIE DESIGNS, PG. 25
© Alex Spatz, Cliffside Studio, East Stroudsburg PA

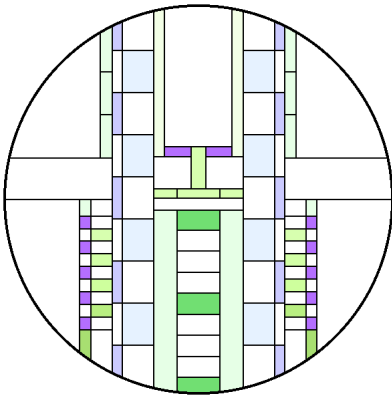

#24-16 PRAIRIE DESIGNS, PG. 30
© Alex Spatz, Cliffside Studio, East Stroudsburg PA

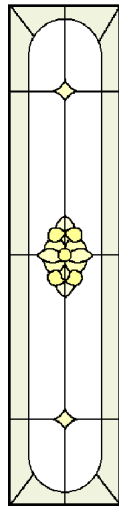

#16-41
SIDELIGHT
GEOMETRIC
© Rick Hecht, SGO
Designer Glass, St.
Louis MO

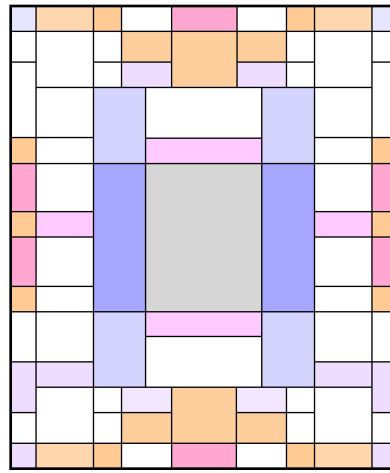

#24-24 PRAIRIE DESIGNS, PG. 36
© Alex Spatz, Cliffside Studio, East Stroudsburg PA

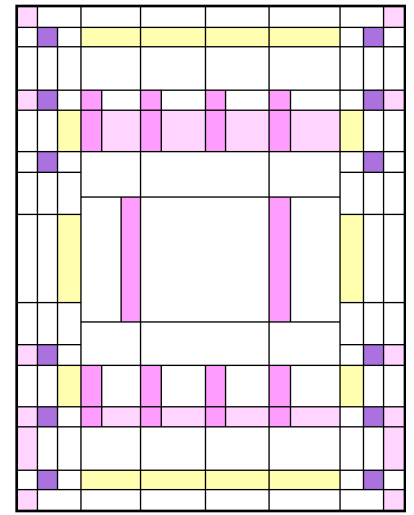

#24-25 PRAIRIE DESIGNS, PG. 37
© Alex Spatz, Cliffside Studio, East Stroudsburg PA

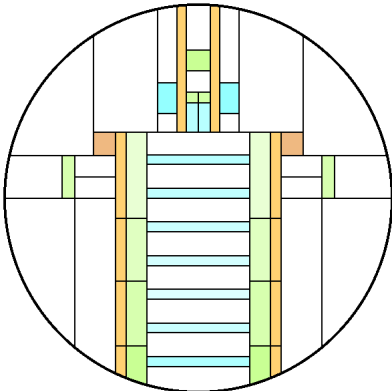

#24-15 PRAIRIE DESIGNS, PG. 29
© Alex Spatz, Cliffside Studio, East Stroudsburg PA

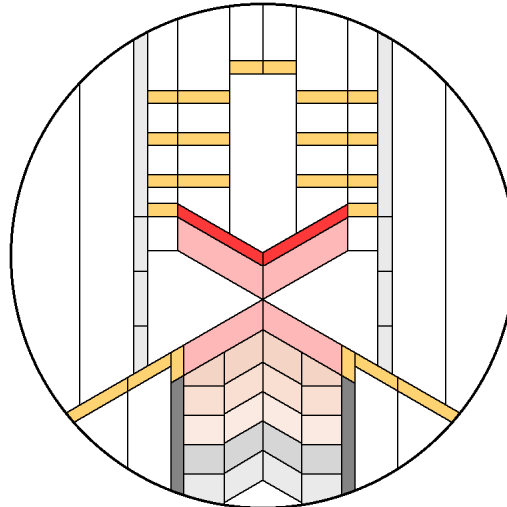

#24-21 PRAIRIE DESIGNS, PG. 33
© Alex Spatz, Cliffside Studio, East Stroudsburg PA

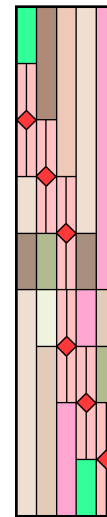

#27-63
GEOMETRIC
DESIGN
© Karen Painter,
Coloured Vision, Tucson AZ

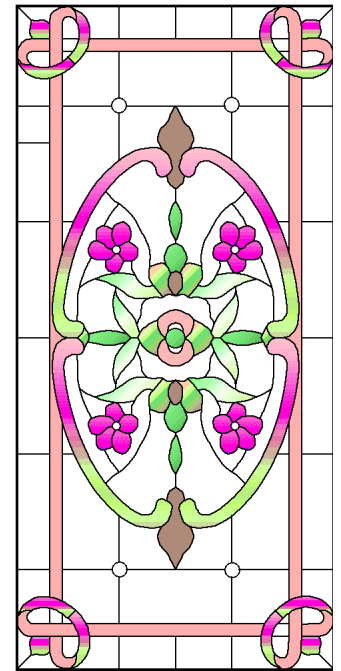

#26-92 ORIENTAL RUG
© Susanne Clarke, Scarab Glass Works, Fresno CA

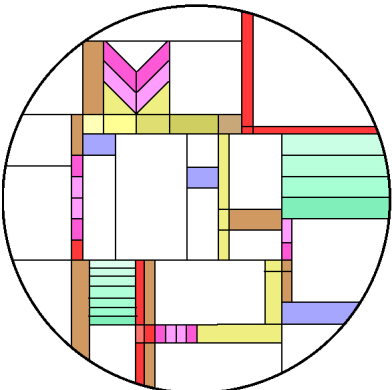

#24-26 PRAIRIE DESIGNS, PG. 18
© Alex Spatz, Cliffside Studio, East Stroudsburg PA

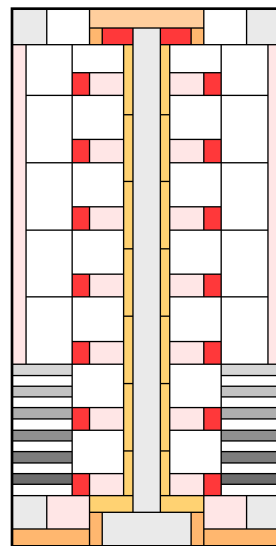

#24-22 PRAIRIE DESIGNS,
PG. 34
© Alex Spatz, Cliffside Studio, East Stroudsburg PA

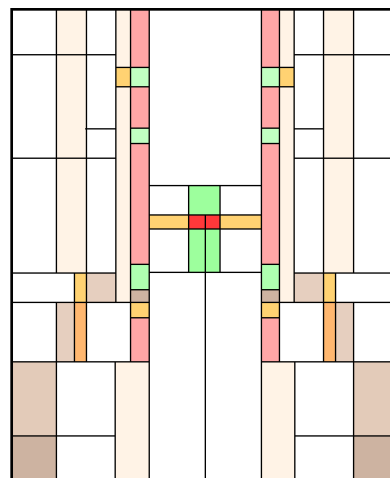

#24-17 PRAIRIE DESIGNS, PG. 31C
© Alex Spatz, Cliffside Studio, East Stroudsburg PA

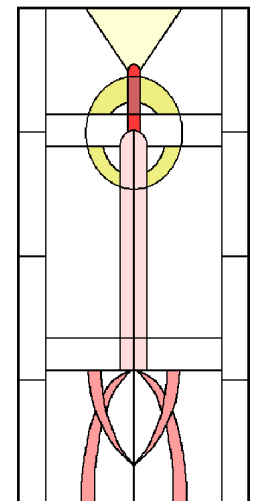

#27-67 ART DECO DESIGN
© Karen Painter, Coloured Vision, Tucson AZ

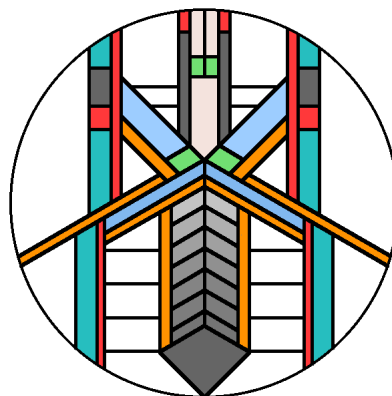

#24-11 PRAIRIE DESIGNS, PG. 26
© Alex Spatz, Cliffside Studio, East Stroudsburg PA

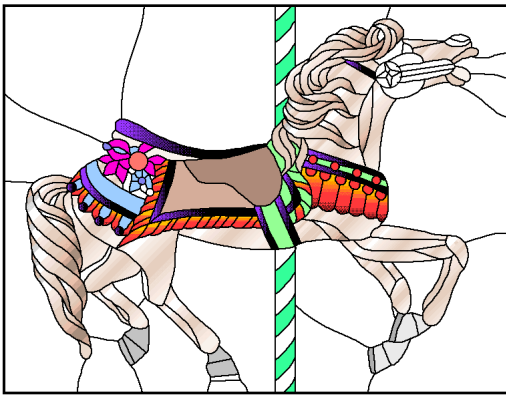

#25-666 CAROUSEL HORSE
© Aurora Publications, Cal Studio, San Jose CA

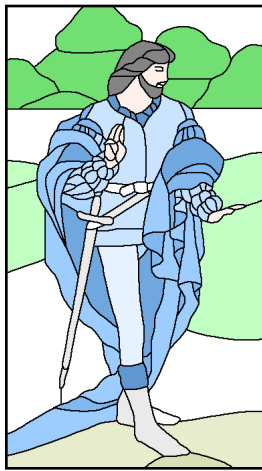

#25-659 ENCHANTED PRINCE
© Aurora Publications, Cal Studio, San Jose CA

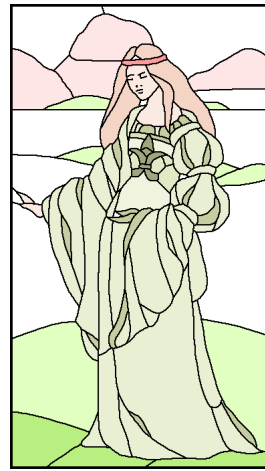

#25-660 ENCHANTED PRINCESS
© Aurora Publications, Cal Studio, San Jose CA

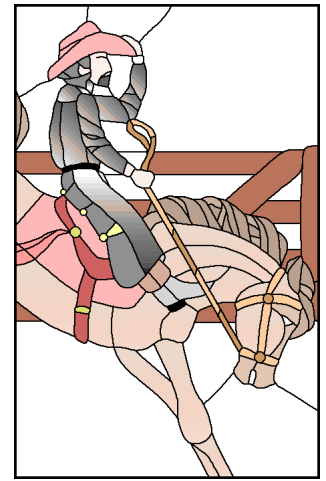

#25-661 RODEO COWBOY
© Aurora Publications, Cal Studio, San Jose CA

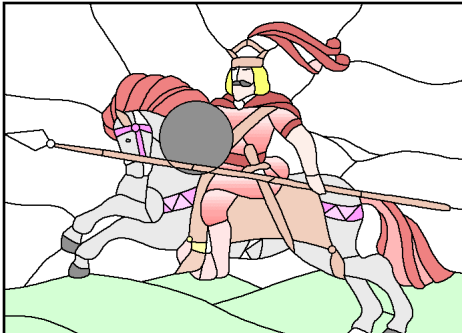

#25-662 KING ON HORSE
© Aurora Publications, Cal Studio, San Jose CA

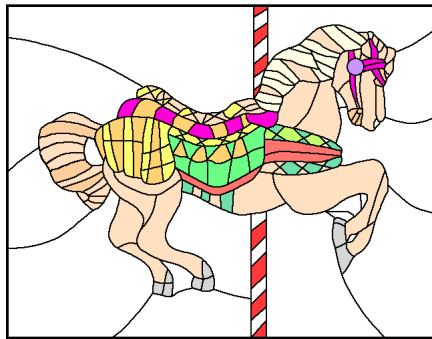

<#25-510 CAROUSEL HORSE IN PROFILE
© Aurora Publications, Cal Studio, San Jose CA

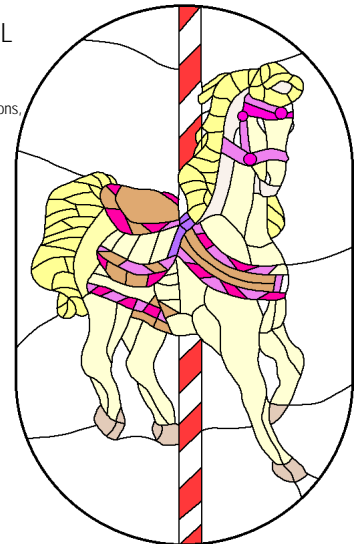

#25-511 CAROUSEL HORSE APPROACHING
© Aurora Publications, Cal Studio, San Jose CA

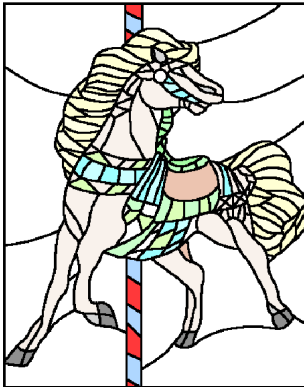

#25-509 CAROUSEL HORSE TURNING
© Aurora Publications, Cal Studio, San Jose CA

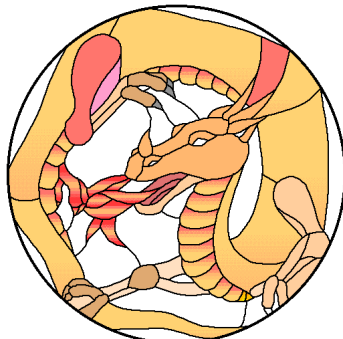

#25-663 DRAGON
© Aurora Publications, Cal Studio, San Jose CA



< #25-657 SOPHISTICATED MAN & LADY (SET OF 2)
© Aurora Publications, Cal Studio, San Jose CA

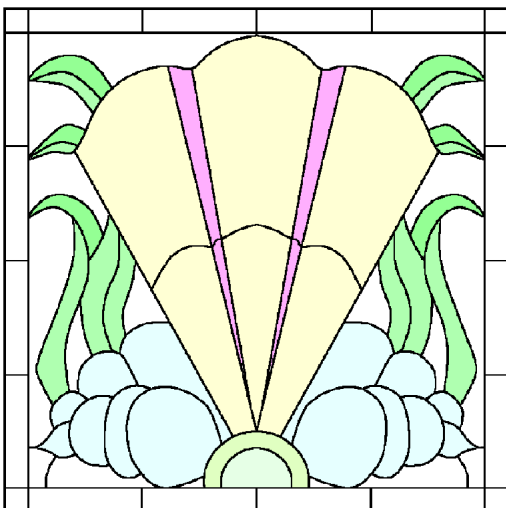

#16-54 UNDERWATER SHELL DESIGN
© Rick Hecht, SGO Designer Glass, St. Louis MO

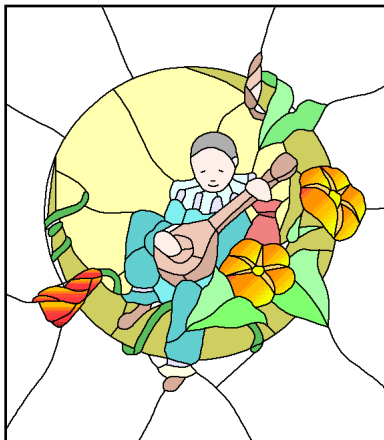

#25-639 PIERROT
© Aurora Publications, Cal Studio, San Jose CA

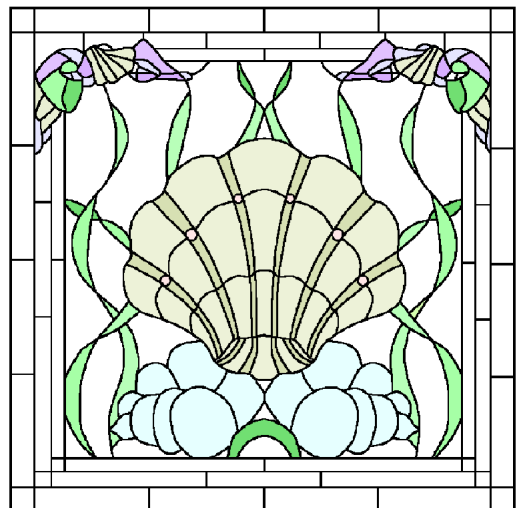

#16-53 UNDERWATER SEASHELL & PLANTS
© Rick Hecht, SGO Designer Glass, St. Louis MO

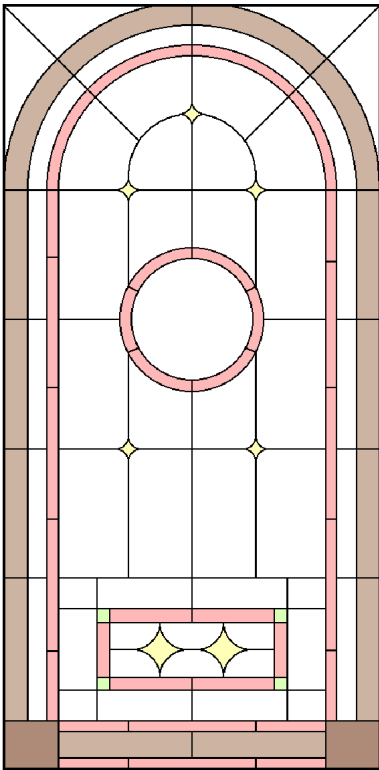

#12-09 ARCH BORDER WITH CIRCULAR MEDALLION
© Charles F. Ottolini, Ottolini Studios, Sevierville TN

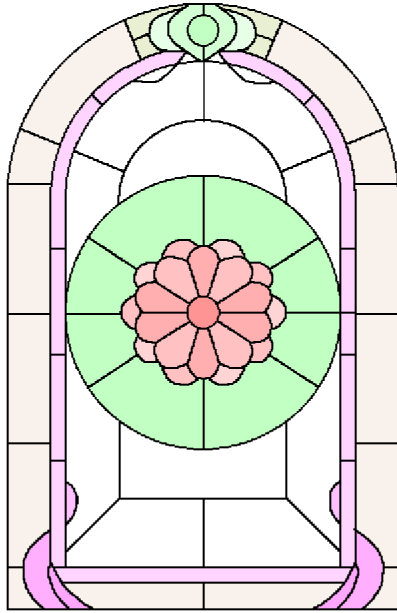

#12-52 GEOMETRIC ARCH TOP
© Charles F. Ottolini, Ottolini Studios, Sevierville TN

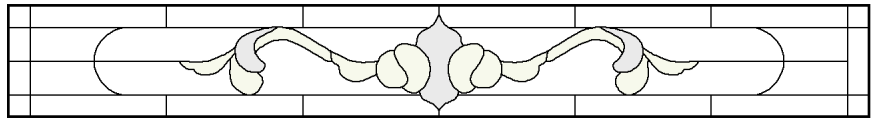

#12-08 TRANSOM
© Charles F. Ottolini, Ottolini Studios, Sevierville TN

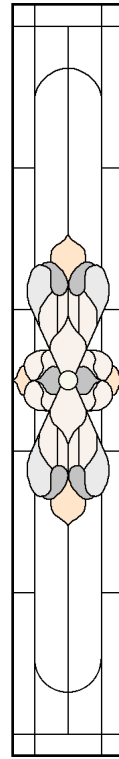

#12-07 SIDELIGHT DESIGN-B
© Charles F. Ottolini, Ottolini Studios, Sevierville TN

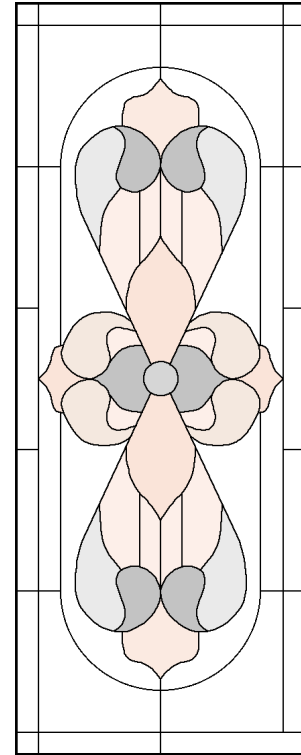

#12-06 DOOR DESIGN
© Charles F. Ottolini, Ottolini Studios, Sevierville TN

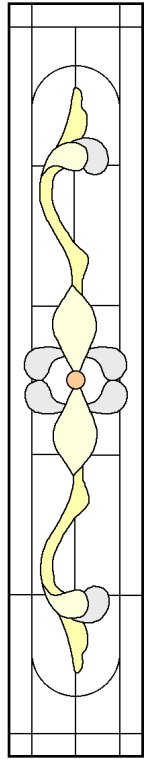

#12-05 SIDELIGHT DESIGN-A
© Charles F. Ottolini, Ottolini Studios, Sevierville TN



#12-73 TULIP TRANSOM
© Charles F. Ottolini, Ottolini Studios, Sevierville TN

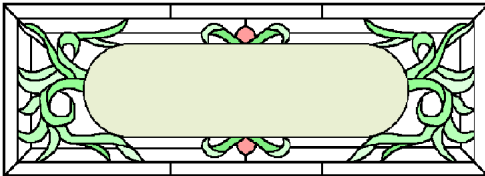

#12-51 ENTRY TRANSOM WITH NAME OR NUMBER
© Charles F. Ottolini, Ottolini Studios, Sevierville TN

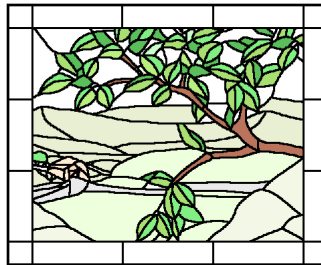

#11-180 COUNTRY SCENE
© Paula Zan, Mything Studio, Hyndman PA

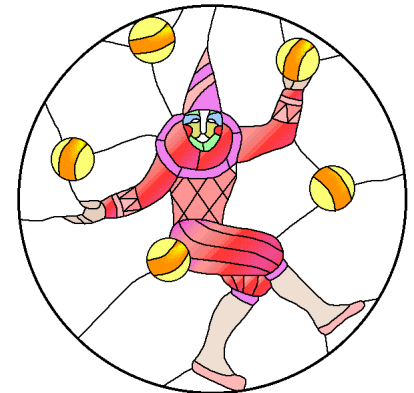

#25-640 > JUGGLING CLOWN
© Aurora Publications, Cal Studio, San Jose CA

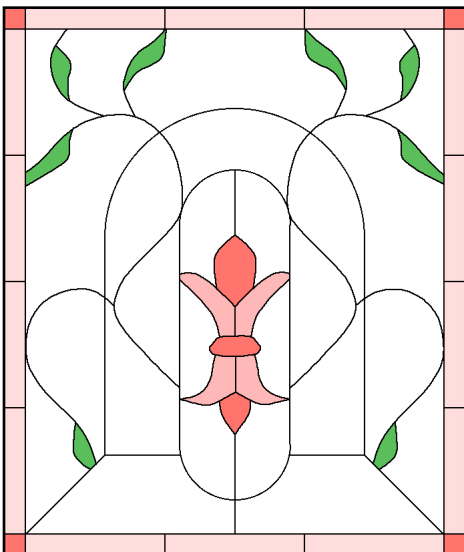

#12-55 VINES & BORDERS
© Charles F. Ottolini, Ottolini Studios, Sevierville TN

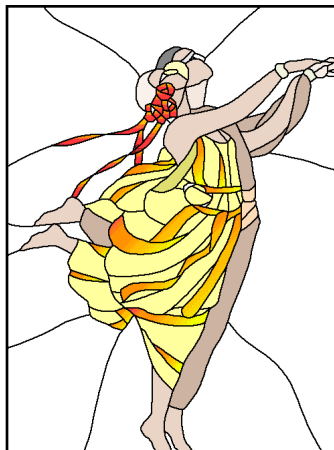

#25-658 DANCERS
© Aurora Publications, Cal Studio, San Jose CA

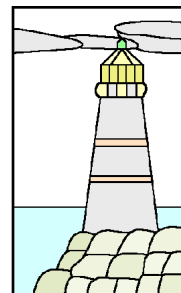

#16-44 LIGHTHOUSE
© Rick Hecht, SGO Designer Glass, St. Louis MO

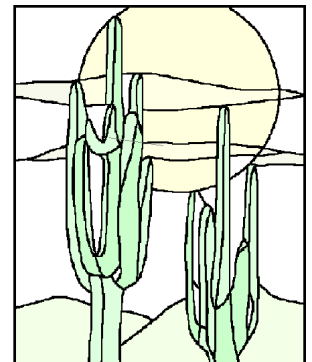

#11-167 DESERT SCENE
© Paula Zan, Mything Studio, Hyndman PA

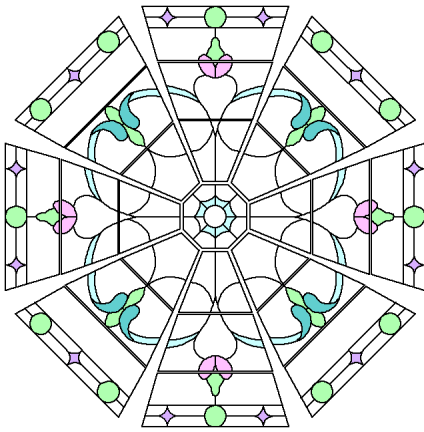

#05-426 FANTASIA (2 PARTS) 4' DOME
© Raymond Voorhees, Pinecrest Fine Art Gallery, Pinecrest CA

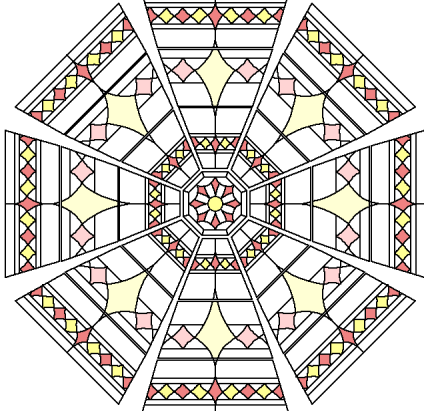

#05-427 DIAMONDS 4' DOME
© Raymond Voorhees, Pinecrest Fine Art Gallery, Pinecrest CA

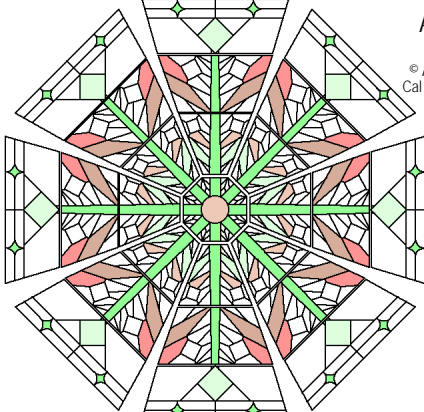

#05-428 SNOWFLAKE 4' DOME
© Raymond Voorhees, Pinecrest Fine Art Gallery, Pinecrest CA

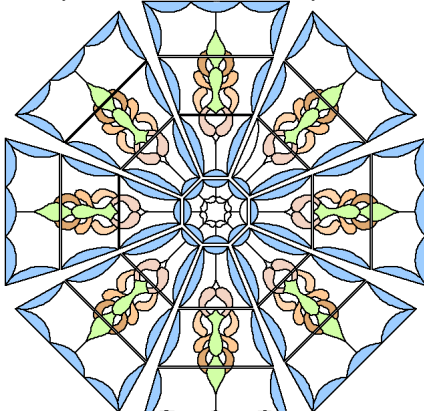

#05-429 SERIZIA 4' DOME
© Raymond Voorhees, Pinecrest Fine Art Gallery, Pinecrest CA



#31-11 UNDERSEA CONTEMPORARY
© Geri Martin Willingham, Stained Glass Design, St. Petersburg FL

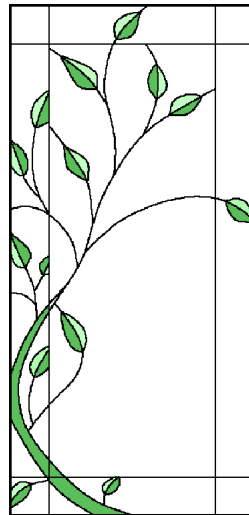

#20-99 PRAIRIE DOOR WITH VINES
© Margaret Cantrell, Detail & Design Farmland IN

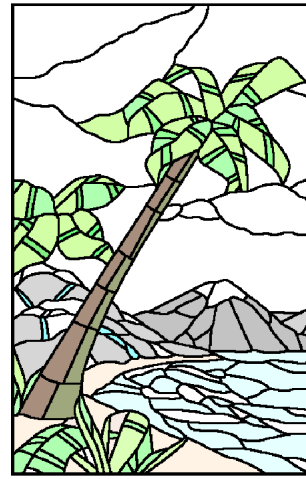

#25-520 TROPICAL LAGOON
© Aurora Publications, Cal Studio, San Jose CA

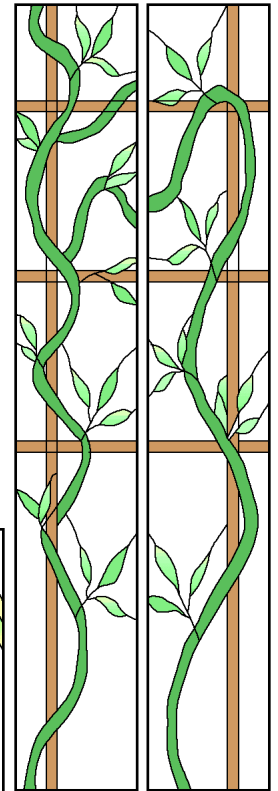

#19-90 LEAVES & TRELLISES (SET OF 2)
© Mary Ann Celinder, Celinder's Glass, Huntington Beach CA

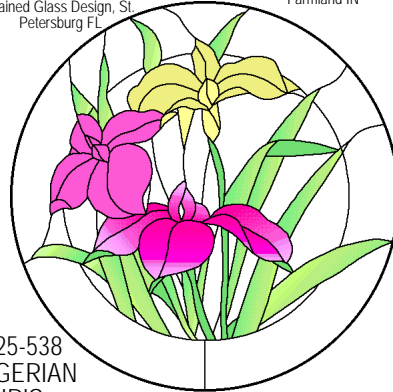

#25-538 ALGERIAN IRIS
© Aurora Publications, Cal Studio, San Jose CA

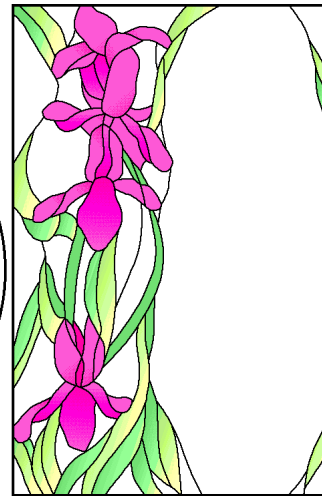

#25-574 IRIS MIRROR
© Aurora Publications, Cal Studio, San Jose CA

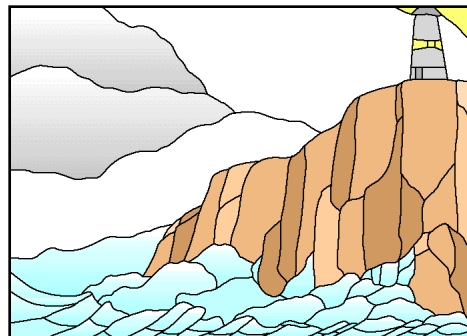

#25-522 LIGHT HOUSE ON THE ROCKS
© Aurora Publications, Cal Studio, San Jose CA

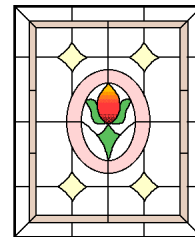

#26-78 VICTORIAN WITH TULIP
© Susanne Clarke, Scarab GlassWorks, Fresno CA

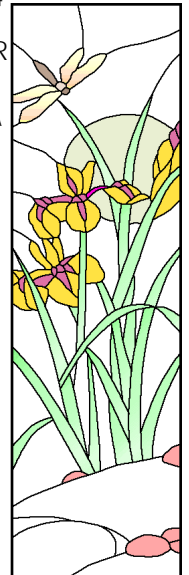

#25-647 ORIENTAL IRISES
© Aurora Publications, Cal Studio, San Jose CA

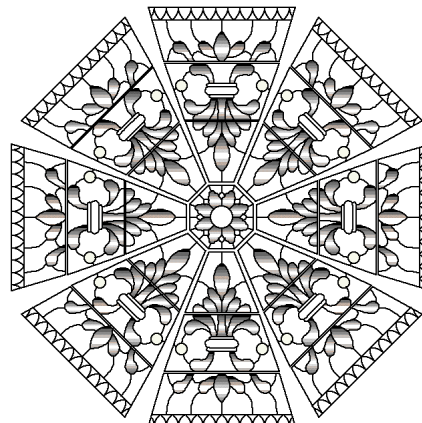

#05-430 FLEUR-DE-LIS 4' DOME
© Raymond Voorhees, Pinecrest Fine Art Gallery, Pinecrest CA

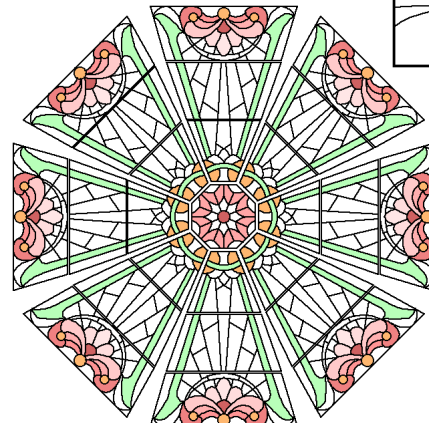

#17-463 OLD WORLD 4' DOME
© Rising Sun Gallery, Midland TX

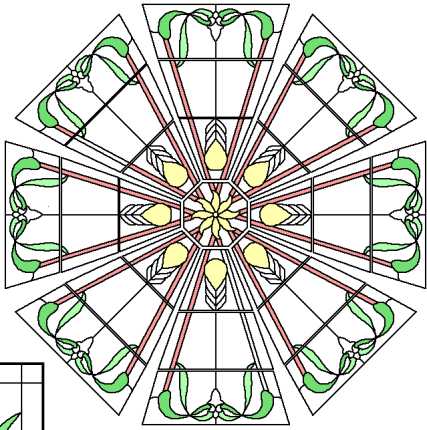

#30-405 FEATHERS 4' DOME
© Robert Pappas, Pappas Studio, Laytonville CA

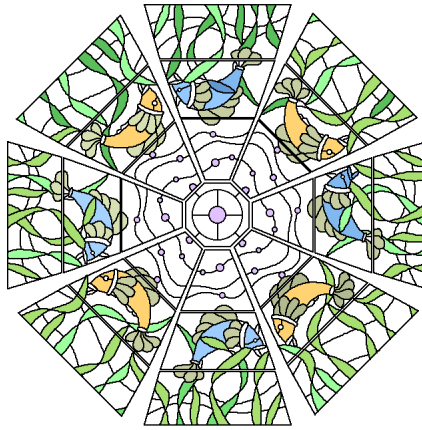

#33-401 FISH BOWL 4' DOME
© Robert DeGrasse, Robert DeGrasse, AIA, Modesto CA

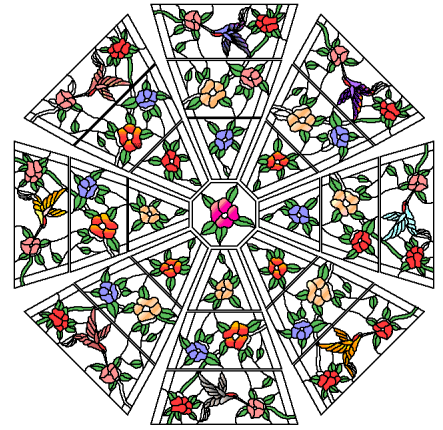

#22-427 DOGWOOD 4' DOME
© Randy Bridwell, Designer Glass, Greers Ferry AR

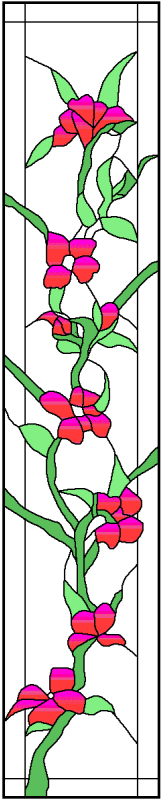

#26-35 DOGWOOD
© Susanne Clarke, Scarab Glass Works, Fresno CA

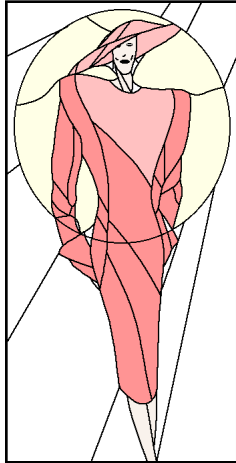

#25-611 HIGH FASHION LADY
© Aurora Publications, Cal Studio, San Jose CA

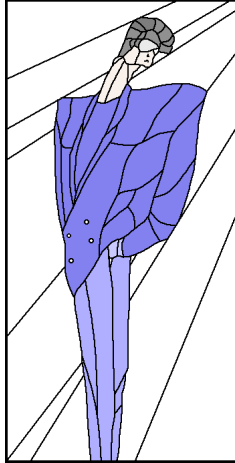

#25-612 HIGH FASHION MAN
© Aurora Publications, Cal Studio, San Jose CA

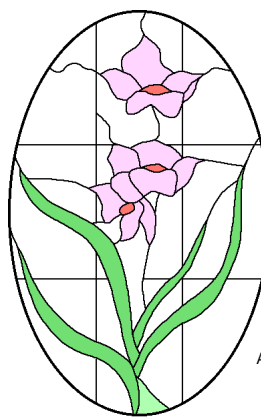

#27-62 FLORAL DOOR PANEL
© Karen Painter, Coloured Vision, Tucson AZ

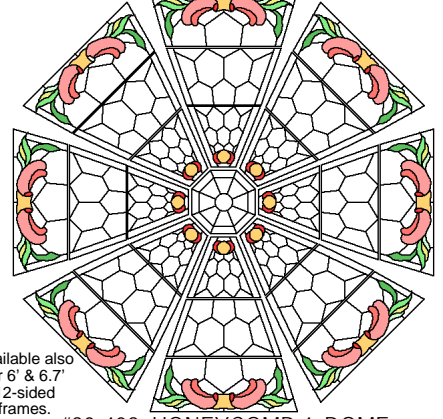

Available also for 6' & 6.7' 12-sided frames.

#30-402 HONEYCOMB 4' DOME
© Robert Pappas, Pappas Studio, Laytonville CA

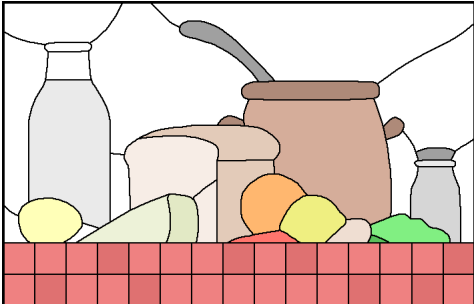

#25-635 KITCHEN SCENE
© Aurora Publications, Cal Studio, San Jose CA

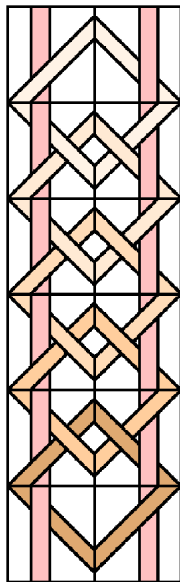

#19-89 TRELLIS GRILLE
© Mary Ann Celinder, Celinder's Glass, Huntington Beach CA

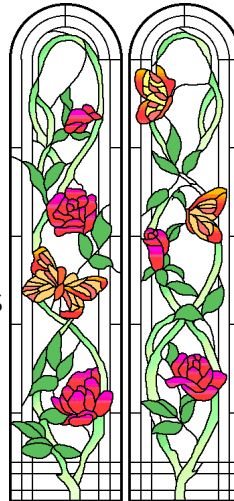

#26-80 BUTTERFLIES & ROSES (2 PANELS)
© Susanne Clarke, Scarab Glass Works, Fresno CA

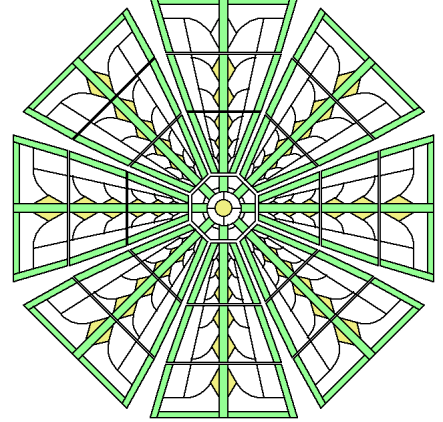

#30-403 DECO 4' DOME
© Robert Pappas, Pappas Studio, Laytonville CA

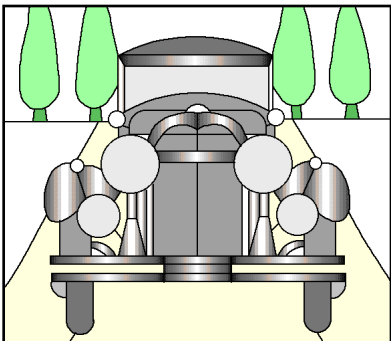

#25-668 CLASSIC CAR
© Aurora Publications, Cal Studio, San Jose CA

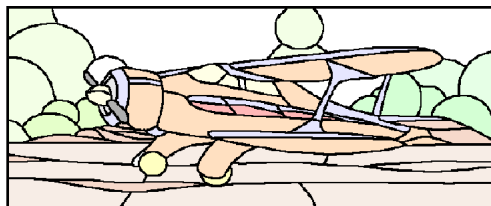

#25-671 AIRPLANE
© Aurora Publications, Cal Studio, San Jose CA

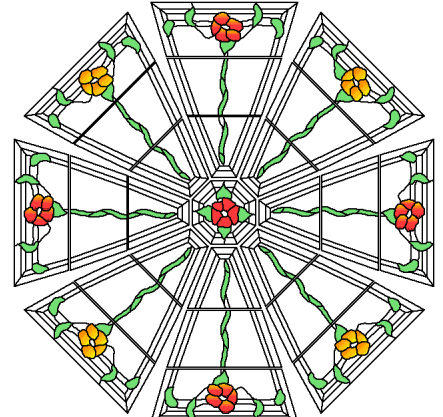

#30-404 FLOWER 4' DOME
© Robert Pappas, Pappas Studio, Laytonville CA

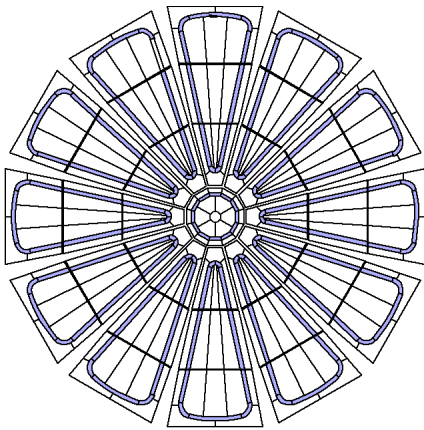

#50-626 WEB 6' DOME

© Dale Lerch, Sierra Stained Glass Studios Inc, Modesto CA

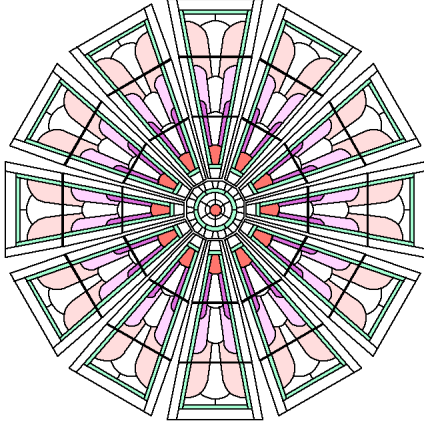

#50-621 CASCADE 6' DOME

© Dale Lerch, Sierra Stained Glass Studios Inc, Modesto CA

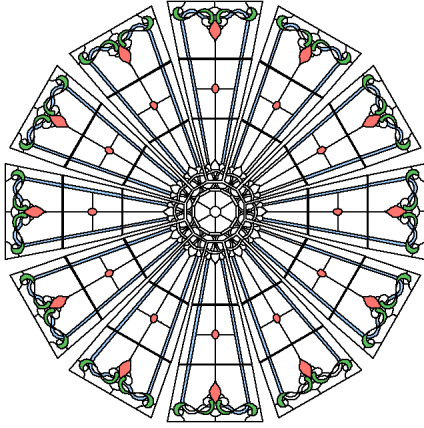

#50-623 NOUVEAU 6' DOME

© Dale Lerch, Sierra Stained Glass Studios Inc, Modesto CA

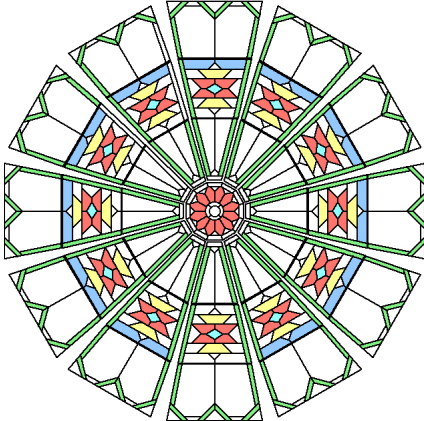

#50-624 NAVAJO 6' DOME

© Dale Lerch, Sierra Stained Glass Studios Inc, Modesto CA

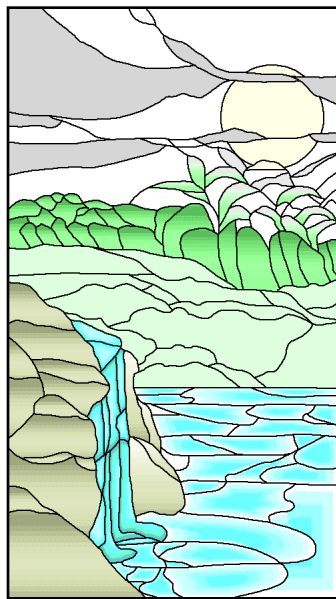

#26-90 HAWAIIAN NIGHTS #1

© Susanne Clarke, Scarab Glass Works, Fresno CA

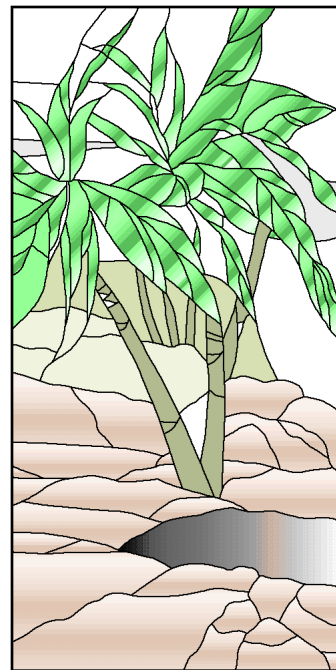

#26-87 HAWAIIAN NIGHTS #2

© Susanne Clarke, Scarab Glass Works, Fresno CA

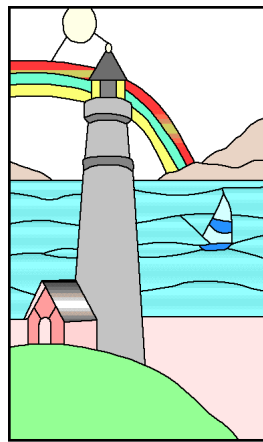

#25-672 LIGHTHOUSE

© Aurora Publications, Cal Studio, San Jose CA

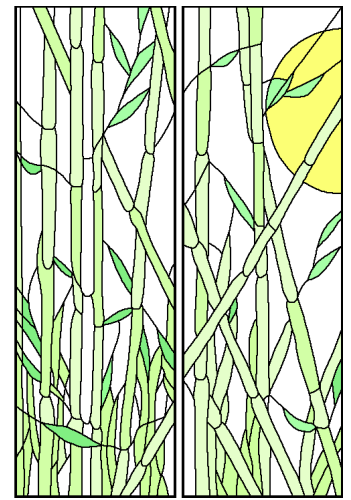

#25-516 BAMBOO SIDELITES (Set of 2)

© Aurora Publications, Cal Studio, San Jose CA



#25-617 GEISHA WITH BOOK

© Aurora Publications, Cal Studio, San Jose CA

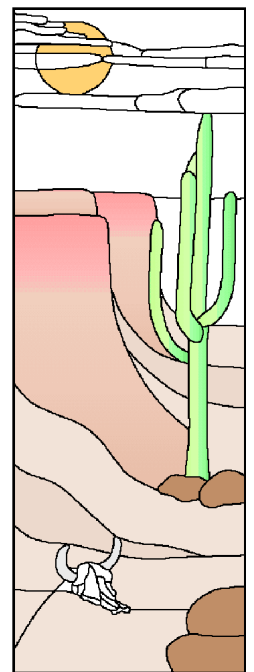

#14-25 THE DESERT

© Roger E. Derden, Stained Glass Studio, Livingston TX



#26-82 VICTORIAN CIRCLE

© Susanne Clarke, Scarab Glass Works, Fresno CA

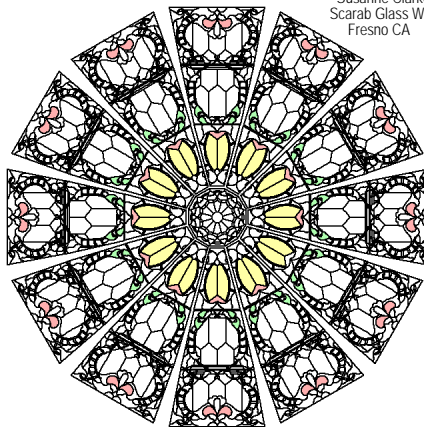

#13-601 LA ROYALE 6' DOME

© Barbara Williamson, Pane In The Glass Inc, Ft. Lauderdale FL

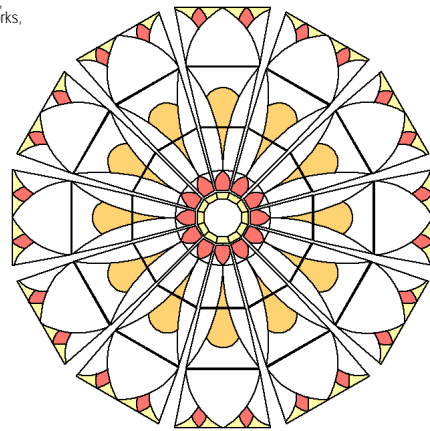

#50-707 LOTUS 7' DOME

© Dale Lerch, Sierra Stained Glass Studios Inc, Modesto CA

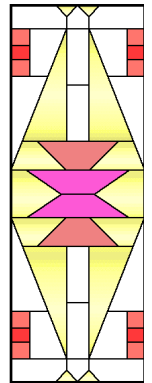

#27-61 CLERESTOY WINDOW MIRROR

© Karen Painter, Coloured Vision, Tucson AZ

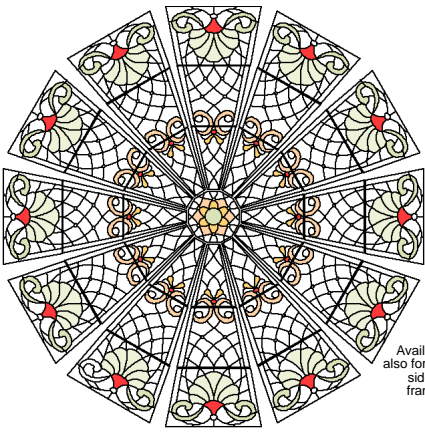

Available also for 8' 16-sided frame.

#32-730 SHELL 7' DOME

© Shanon Matesio, Mc Mow Art Glass, Lake Worth FL

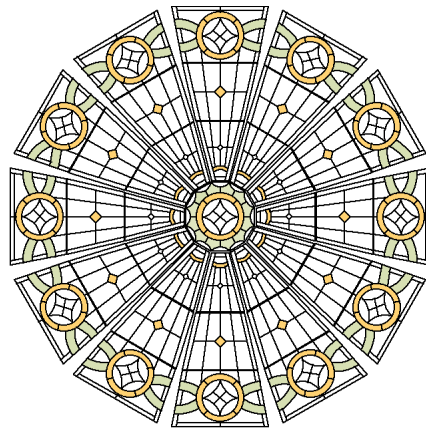

#50-808 SAVOY 8' DOME

© Dale Lerch, Sierra Stained Glass Studios Inc, Modesto CA

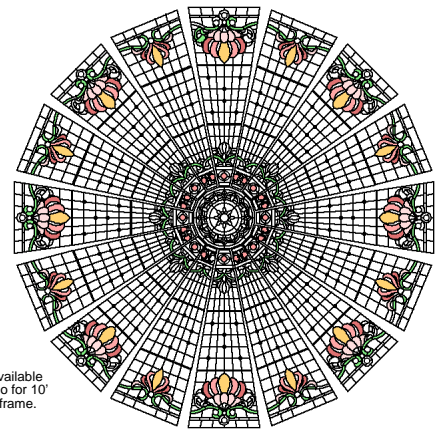

Available also for 10' frame.

#50-802 VICTORIAN 8' DOME

© Dale Lerch, Sierra Stained Glass Studios Inc, Modesto CA

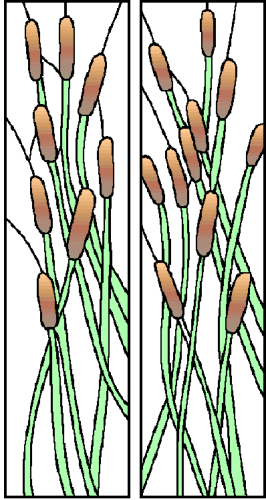

#25-565 CATTAIL SIDELITES (SET of 2)

© Aurora Publications, Cal Studio, San Jose CA



#25-616

GEISHA WITH FAN

© Aurora Publications, Cal Studio, San Jose CA

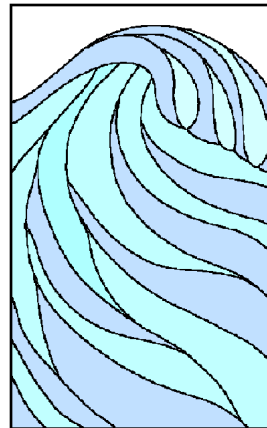

#19-77 LARGE WAVE

© Mary Ann Celinder, Celinder's Glass, Huntington Beach CA

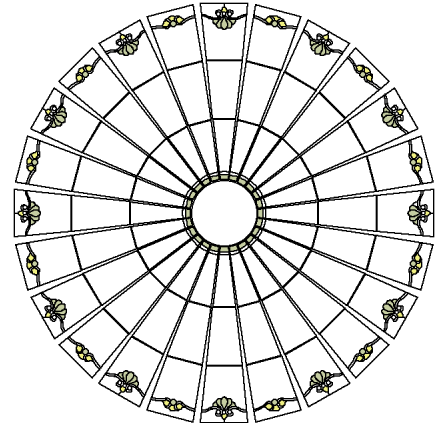

#50-101 SCROLL 10' DOME

© Dale Lerch, Sierra Stained Glass Studios Inc, Modesto CA

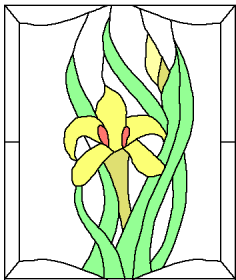

#26-73 IRIS

© Susanne Clarke, ScarabGlassWorks, Fresno CA

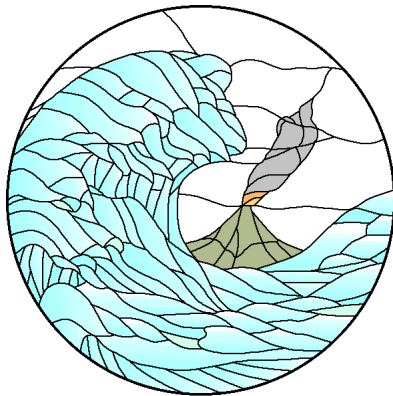

#25-518 VOLCANO IN THE WAVE

© Aurora Publications, Cal Studio, San Jose CA



#18-71 ABANDONED LIGHTHOUSE

© Rosalie Smith, Coquille OR

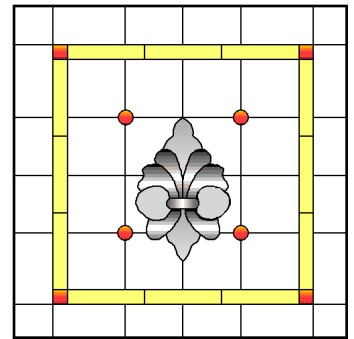

#26-36 FLEUR DE LIS

© Susanne Clarke, Scarab Glass Works, Fresno CA

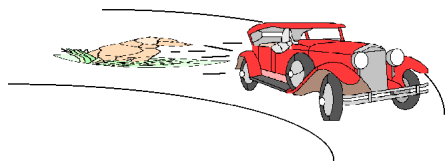

Watch your Width/Height Ratios when you custom-size patterns so your pattern doesn't look as though it's been run over!

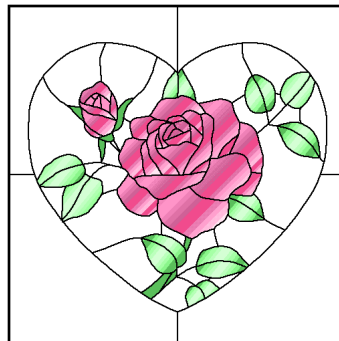

#25-650 ROSES IN HEART

© Aurora Publications, Cal Studio, San Jose CA

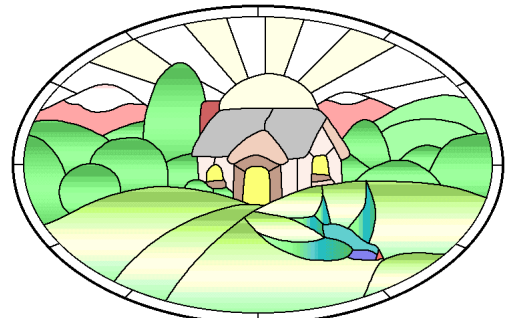

#25-669 COTTAGE IN THE HILLS

© Aurora Publications, Cal Studio, San Jose CA

Standard Recessed Dome Frames

Effective 3/1/22

All frames are shipped disassembled by UPS or FedEx Ground.

Assembly time required: ~0.3 to 1 hr.

Key Data on Frames & Installation Framing

(See Typical Installation Guidelines for more detailed information. 12-, 16-, and 24-sided frames normally installed over ROUND openings.)

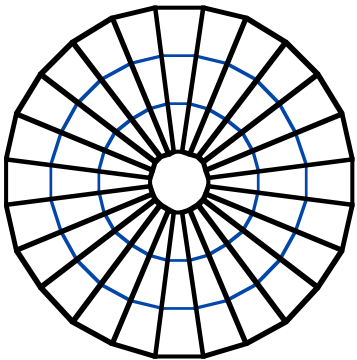

10450, 11450, 12400

Frame Number	Frame Size (at base) / No. of Sides	Frame Height inches	Weight Frame (lbs)	Weight, Frame + Glass	*No. of Glass Panels	Installation Framing, Centers	**Soffit Height
4850	45.5" / 8-sided	12	18	57	24/25	48x48	15"
4850X5	45.5" x 57.5" / 8	12	20	71	25	48x60	15"
4850X6	45.5" x 69.5" / 8	14	24	88	32	48x72	16"
4850X8	45.5" x 93.5" / 8	14	30	118	39	48x96	16"
4850X10 ***	45.5" x 117.5" / 8	14	37	149	46	48x120	16"
5250 ***	57.8" x 57.8" / 12	14	28	90	36/37	60x60	18"
5250X8 ***	57.8" x 93.5" / 12	16	40	148	51	60x96	19"
5850 ***	57.6" x 57.6" / 8	16	23	89	24/25	60x60	19"
5853X7 ***	57.6" x 81.5" / 8	18	33	130	39	60x84	21"
6250	69.3" / 12-sided	18	34	124	36/37	72x72	22"
6250X10 ***	69.3"x123.3" / 12	20	54	229	58	72x126	23"
6250X12 ***	69.3"x141.5" / 12	20	61	265	65	72X144	23"
6800 ***	69.6" x 69.6" / 8	18	27	123	24/25	72x72	22"
7250	77.5" / 12-sided	20	38	153	36/37	80x80	24"
7250X10 ***	77.5"x117.5" / 12	22	54	240	51	80x120	25"
7250X13 ***	77.5" x 160" / 12	22	69	330	65	80x162	25"
8250 ***	93.5" / 12-sided	23	46	213	36/37	96x96	28"
8250X10 ***	93.5"x117.5" / 12	25	55	275	44	96x120	29"
8650	92.6" / 16-sided	23	54	215	48/49	96x96	28"
8650X12 ***	92.6"x146.5" / 16	25	79	355	70	96x149	29"
8856 ***	93.5"/8-sided 16§	24	43	220	48/49	96x96	29"
9653 ***	106"/16-sided	25.5	62	277	48/49	108x108	30"
10450	123" / 24-sided	29	97	380	73	10' circle	37"
12450****.75	147" / 24-sided	37	148	570	73	12' circle	48"

* Frames with hanging chandelier (xxxx-5) center have no center glass panel.
 ** Soffit (above dome for lighting) must be sealed tightly to prevent glass panels from lifting out!
 *** These frames are non-standard and not always in stock. Allow time for custom manufacture.
 **** Frames larger than 10' are not fully self-supporting frames. (Requires cable supports for each arm.)

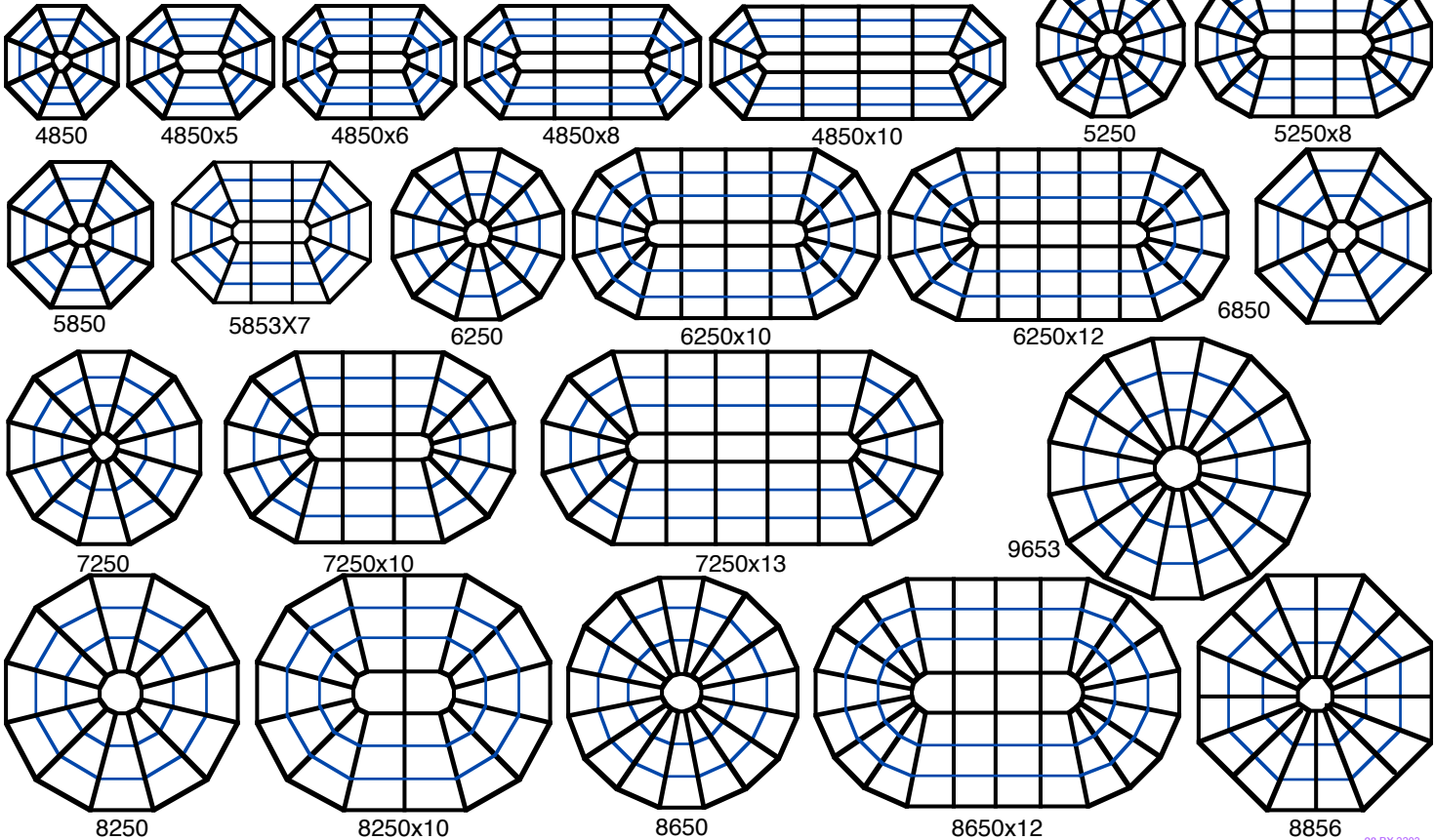



Clockwise from Upper Left:
 1) SupraDome 7 (77.5" / 12-sides) with Customized Textured Clears & Brass Comes & Chandelier center top plate;
 2) SupraDome 7 (77.5" / 12-sides) with Cascade design;
 3) The Dome (45.5" / 8-sides) with Bordered Clears & Brass Comes & Chandelier center top plate, white frame;
 4) The Dome Elongated (4' x 5') with Nouveau design;
 5) & 6) SupraDome 10 (123" / 24-sides) with custom design.





SupraDome 6
(12-sided)

Both dome frames
from the patented
line of dome frames
manufactured by
Sierra Stained
Glass Studios
Modesto, CA



SupraDome 8
(16-sided)

Glass Design by Feather River Wood & Glass, Colors by Sierra Stained Glass Studios, Executed by World Wide Glass Products



Glass Design by Feather River Wood & Glass, Executed by World Wide Glass Products

*The Domes of
Martin Lawrence Galleries
Newest Addition, 366 Geary Avenue
of San Francisco, CA*



Pattern Listing of PRICES, Standard SIZES, Range of Acceptable Width / Height Ratios, Number of Pieces in Pattern

1/98 Edition (All measurements in INCHES)

Pattern Number	Price	Pattern Name	Catlg. Page	N ^o of Pieces	Standard Pattern Size		Std. Size W/H Ratio	Acceptable Ratio Range for Custom Sizing		Min. Width
					Width	x Height		Min	Max	
01-01	\$7.95	Dairyman's Dream Cow	3	48	26	x 18	1.44	1.28 - 1.66	14	
02-02	\$8.95	ROPIN' COWBOY -1	1	105	34	x 17	2.00	1.66 - 2.45	24	
02-03	\$8.95	ROPIN' COWBOY -2	1	43	34	x 17	2.00	1.66 - 2.45	24	
02-04	\$19.95	RIVER HORSES	1	505	45	x 32.5	1.38	1.16 - 1.69	32	
02-05	\$10.95	DOGWOOD & Bevels	2	227	23	x 42	0.55	0.40 - 0.70	18	
02-06	\$12.95	ORGAN MOUNTAINS	3	362	46	x 23	2.00	1.50 - 2.90	24	
02-07	\$9.95	IRISES	1	224	18	x 30	0.60	0.45 - 0.75	14	
03-08	\$8.95	MERMAID	2	120	18	x 18	1.00	0.75 - 1.20	12	
04-10	\$9.95	VIKING SHIP	7	124	30	x 23	1.30	0.90 - 1.71	18	
04-11	\$7.95	TWO WHALES	3	48	20	x 16	1.25	0.85 - 1.85	12	
04-12	\$5.95	BIRD OF PARADISE	6	35	17	x 12	1.42	0.88 - 1.80	11	
04-13	\$7.95	HOT AIR BALLOONS	3	28	12	x 23	0.52	0.41 - 0.66	9	
04-14	\$8.95	LIGHTHOUSE	7	78	17	x 34	0.50	0.33 - 0.56	12	
04-16	\$6.95	EGRET	9	34	20	x 16	1.25	0.90 - 1.70	12	
04-17	\$5.95	Greek DRAMA MASK	3	26	12	x 12	1.00	0.78 - 1.30	9	
04-18	\$10.95	MONUMENT VALLEY	7	91	29	x 23	1.26	0.82 - 1.65	16	
04-19	\$7.95	SEA HORSE	1	59	12	x 16	0.75	0.57 - 1.00	9	
04-21	\$7.95	QUAIL & BERRIES	5	59	16	x 16	1.00	0.78 - 1.16	11	
05-426	\$10.95	FANTASIA 4' DOME	22	241	Requires dome frame #4850					
05-427	\$9.95	DIAMONDS 4' Dome	22	634	Requires dome frame #4850					
05-428	\$9.95	Snowflake 4' Dome	22	568	Requires dome frame #4850					
05-429	\$9.95	SERIZIA 4' DOME	22	354	Requires dome frame #4850					
05-430	\$9.95	Fleur-de-Lis 4' Dome	22	609	Requires dome frame #4850					
06-31	\$7.95	FLORAL BOUQUET	1	90	12	x 23.5	0.51	0.37 - 0.62	9	
06-36	\$6.95	6 TULIP DESIGN	5	49	12	x 23.5	0.51	0.36 - 0.60	9	
06-37	\$6.95	AUTUMN IVY	5	75	12	x 23.5	0.51	0.40 - 0.62	9	
06-38	\$7.95	HUMMINGBIRD	2	60	12	x 23.5	0.51	0.40 - 0.95	9	
06-40	\$7.95	FLOWER CLUSTER	3	62	12	x 23.5	0.51	0.40 - 0.69	9	
06-41	\$7.95	4 FLOWER DESIGN	1	130	12	x 24	0.50	0.39 - 0.65	10	
06-42	\$7.95	PAISLEY DESIGN	5	80	12	x 23.5	0.51	0.30 - 0.75	9	
06-43	\$9.95	TULIP & LEAVES	2	73	12	x 23.5	0.51	0.30 - 0.72	9	
07-07	\$7.95	Underwater JUNGLE	7	166	20	x 30	0.67	0.50 - 1.00	14	
07-08	\$7.95	BLOOMING ROSES	7	88	23	x 23	1.00	0.76 - 1.16	16	
07-10	\$8.95	CALLA	7	161	9	x 46	0.20	0.14 - 0.25	6	
07-15	\$9.95	FLOWER JUNGLE	7	217	42	x 21	2.00	1.75 - 2.38	24	
09-47	\$9.95	ADVENT	4	100	16	x 41	0.39	0.27 - 0.47	12	
09-49	\$9.95	PENTECOST	4	105	20	x 41	0.49	0.38 - 0.60	14	
09-51	\$9.95	EPIPHANY	4	139	16	x 41	0.39	0.25 - 0.55	12	
09-52	\$9.95	CHRISTMAS	4	101	16	x 42	0.38	0.23 - 0.60	11	
09-56	\$9.95	EUCHARIST	4	196	21	x 32	0.66	0.50 - 0.90	15	
09-57	\$6.95	VICTORIAN LILY	5	68	16	x 25.5	0.63	0.40 - 1.00	12	
09-58	\$7.95	DOVE OF JOY	4	91	23	x 23	1.00	0.75 - 1.20	15	
09-60	\$8.95	DOVE OF PEACE	4	139	30	x 42	0.71	0.56 - 0.92	18	
09-61	\$9.95	TREE OF LIFE	4	166	30	x 42	0.71	0.50 - 0.77	20	
10-40	\$7.95	DESERT VIEW	7	50	46	x 23	2.00	1.60 - 2.80	18	
11-063	\$5.95	PENITENT POOCH	1	49	14	x 14	1.00	0.83 - 1.15	10	
11-065	\$6.95	THE WIZARD	2	88	18	x 20	0.90	0.75 - 1.10	14	
11-066	\$8.95	Camouflaged BUCK	7	203	34	x 22	1.55	1.28 - 1.77	23	
11-067	\$6.95	TUDOR ROSE	7	126	12	x 24	0.50	0.40 - 0.60	10	
11-072	\$9.95	DRESSAGE 1	7	181	23	x 21	1.10	0.95 - 1.36	17	
11-077	\$9.95	IRISH SETTERS	5	150	40	x 34	1.18	1.06 - 1.50	20	
11-078	\$5.95	WHITE TAIL DEER	7	58	15	x 17	0.88	0.75 - 1.05	8	
11-080	\$7.95	THE HUNTRESS	3	119	23	x 28	0.82	0.60 - 1.00	16	
11-086	\$7.95	PIRATE'S TREASURE	5	100	16	x 23	0.70	0.60 - 0.88	11	
11-093	\$8.95	MYTHLING MAGICIAN	5	95	12	x 30	0.40	0.31 - 0.55	8	

Pattern Listing of PRICES, Standard SIZES, Range of Acceptable Width / Height Ratios, Number of Pieces in Pattern

1/98 Edition (All measurements in INCHES)

Pattern Number	Price	Pattern Name	Catlg. Page	N ^o of Pieces	Standard Pattern Size		Std. Size W/H Ratio	Acceptable Ratio Range for Custom Sizing		Min. Width
					Width	x Height		Min	Max	
11-095	\$9.95	BLUEBIRD	1	151	20.75	x 20	1.04	0.80 - 1.30	17	
11-097	\$8.95	DAPPER CLOWN	1	71	16	x 20	0.80	0.70 - 0.90	12	
11-098	\$9.95	TIMBER WOLF	2	119	20	x 20	1.00	0.85 - 1.10	15	
11-099	\$9.95	COCKATOO	6	207	23	x 23	1.00	0.85 - 1.20	20	
11-100	\$8.95	ROSE WINDOW	12	196	23	x 32	0.72	0.60 - 0.85	14	
11-101	\$9.95	THE WINNER	6	146	24	x 21	1.14	0.95 - 1.25	22	
11-103	\$6.95	SWAN PORTRAIT	7	68	20	x 18	1.11	1.00 - 1.24	14	
11-105	\$7.95	SADDLE BRONCO	2	89	16	x 16	1.00	0.90 - 1.15	14	
11-115	\$8.95	BARREL RACER	2	140	20	x 17	1.18	1.00 - 1.35	15	
11-125	\$36.00	Mountain Lake (Full Set)	6	358	20	x 40	0.50	0.42 - 0.60	12	
11-125A	\$10.95	Mountain Lake #A	6	138	20	x 40	0.50	0.42 - 0.60	12	
11-125B	\$10.95	Mountain Lake #B	6	62	20	x 40	0.50	0.42 - 0.60	12	
11-125C	\$10.95	Mountain Lake #C	6	60	20	x 40	0.50	0.42 - 0.60	12	
11-125D	\$10.95	Mountain Lake #D	6	98	20	x 40	0.50	0.42 - 0.60	12	
11-131	\$8.95	HUMMINGBIRD	1	243	12	x 30	0.40	0.33 - 0.48	9	
11-141	\$9.95	SCARLET MACAW	7	185	19	x 46	0.41	0.33 - 0.44	9	
11-143	\$7.95	AUTUMN GLORY	7	106	22	x 20	1.10	0.85 - 1.33	14	
11-148	\$7.95	Steam LOCOMOTIVE	6	123	30	x 12	2.50	2.00 - 3.00	22	
11-149	\$7.95	Mountain BLUEBIRD	5	120	10	x 23	0.43	0.36 - 0.55	10	
11-158	\$24.95	MYTHIC SYNERGY	7	448	26	x 43	0.60	0.45 - 0.75	20	
11-159	\$7.95	SWAN & Reflection	7	71	20	x 20	1.00	0.85 - 1.20	18	
11-163	\$11.95	CATCH OF THE DAY	9	130	32	x 46	0.70	0.50 - 0.80	14	
11-167	\$7.95	DESERT SCENE	21	65	20	x 25	0.80	0.71 - 0.88	14	
11-168	\$7.95	PORTRAIT of a BUCK	14	73	17.5	x 23.5	0.74	0.60 - 1.00	10	
11-169	\$8.95	CESSNA SKYHAWK	2	100	34	x 14	2.43	1.85 - 3.20	23	
11-170	\$8.95	KAYAK & White Water	8	96	33	x 23	1.43	1.10 - 1.75	20	
11-180	\$8.95	COUNTRY SCENE	21	224	22	x 18	1.22	0.80 - 1.50	16	
11-191	\$5.00	African ELEPHANT	2	47	12	x 18	0.67	0.63 - 0.75	8	
11-196	\$5.00	HIPPOPOTAMOS	2	42	12	x 14	0.86	0.80 - 1.00	8	
11-198	\$5.00	LOWLAND GORILLA	2	43	12	x 18	0.67	0.60 - 0.78	9	
11-199	\$5.00	RHINOCEROS	2	61	16	x 12	1.33	1.23 - 1.50	10	
11-200	\$5.00	HIPPOPOTAMOS	2	38	16.5	x 12	1.38	1.25 - 1.50	12	
11-201	\$5.00	AFRICAN LION	2	72	8	x 14.5	0.55	0.50 - 0.62	8	
11-223	\$10.95	IRISH SETTERS	1	234	23	x 23	1.00	0.75 - 1.25	16	
11-225	\$9.95	Calling Up the LIGHT	1	118	23	x 26	0.88	0.70 - 1.15	18	
11-231	\$10.95	WHITETAIL DEER	14	134	29	x 41	0.71	0.59 - 0.80	20	
11-238	\$7.95	ALL PLAYED OUT	14	60	22	x 22	1.00	0.85 - 1.15	15	
11-239	\$6.95	PENSIVE POOCH	3	42	18	x 14	1.29	1.00 - 1.40	12	
11-888	\$5.00	LOVE BIRDS LAMP	15	49	8.4	x 7.2	1.17	1.17 - 1.17	8	
11-908	\$14.95	African GRASSLAND-1	2	128	34.25	x 23	1.49	1.20 - 1.80	24	
11-909	\$11.95	African GRASSLAND-2	2	102	23	x 24	0.96	0.75 - 1.25	18	
11-910	\$14.95	African Waterhole	2	71	46	x 20	2.30	2.00 - 2.70	33	
12-05	\$9.95	SIDELIGHT Design-A	21	47	12	x 68	0.18	0.14 - 0.24	6	
12-06	\$11.95	DOOR DESIGN	21	63	26	x 68	0.38	0.32 - 0.50	14	
12-07	\$9.95	SIDELIGHT Design-B	21	65	10	x 68	0.15	0.12 - 0.25	7	
12-08	\$9.95	TRANSOM	21	47	78	x 10	7.80	5.50 - 9.40	40	
12-09	\$12.95	ARCH BORDERI	21	78	34	x 69	0.49	0.40 - 0.60	20	
12-44	\$8.95	OVAL MEDALLION	12	92	12	x 30	0.40	0.30 - 0.60	7	
12-51	\$7.95	ENTRY TRANSOM	21	101	34	x 12	2.83	2.10 - 3.90	20	
12-52	\$9.95	GEOMETRIC ARCH	21	82	27	x 42	0.64	0.54 - 0.70	15	
12-54	\$8.95	ABSTRACT FLOWER	12	101	34	x 32	1.06	0.90 - 1.30	22	
12-55	\$8.95	VINES & BORDERS	21	62	32	x 38	0.84	0.65 - 1.00	16	
12-67	\$9.95	Kaliedoscopic Floral	12	105	35	x 35	1.00	0.65 - 1.50	12	
12-73	\$8.95	TULIP TRANSOM	21	59	63	x 9	7.00	5.25 - 10.00	34	
12-74	\$9.95	FLOWER & VINES	5	125	30	x 30	1.00	0.83 - 1.20	18	

Pattern Listing of PRICES, Standard SIZES, Range of Acceptable Width / Height Ratios, Number of Pieces in Pattern

1/98 Edition (All measurements in INCHES)

Pattern Number	Price	Pattern Name	Catlg. Page	N ^o of Pieces	Standard Pattern Size		Std. Size W/H Ratio	Acceptable Ratio Range for Custom Sizing		Min. Width
					Width	x Height		Min	Max	
12-78	\$7.95	DENTAL CADVEUS	5	146	23	x 34	0.68	0.50 - 1.00	14	
12-82	\$8.95	DOGWOOD	12	178	29	x 29	1.00	0.72 - 1.40	18	
12-83	\$19.95	Floral TRITYCH (3)	5	318	17.5	x 40	0.44	0.30 - 0.57	10	
12-86	\$9.95	FLORAL SIDELIGHT	6	103	10	x 68	0.15	0.12 - 0.17	7	
12-88	\$11.95	MORNING FLIGHT	11	220	18	x 80	0.23	0.17 - 0.35	10	
12-99	\$7.95	LOTUS	12	85	23	x 34	0.68	0.48 - 0.79	14	
13-03	\$9.95	PERFECT UNION	9	97	34	x 18	1.89	1.40 - 2.44	26	
13-04A	\$11.95	HANGING VINES (L)	3	382	35	x 35	1.00	0.90 - 1.20	24	
13-04B	\$11.95	HANGING VINES (R)	3	437	35	x 35	1.00	0.90 - 1.20	24	
13-05	\$19.95	Hanging Vines (Both)	3	437	63	x 35	1.80	1.60 - 2.10	45	
13-601	\$21.95	LA ROYALE 6' DOME	24	2810	Requires dome frame #6250					
13-821	\$23.95	LA ROYALE 8' DOME	ns	2810	Requires dome frame #8250					
13-861	\$29.95	LA ROYALE 8' Dome	ns	3713	Requires dome frame #8650					
14-23	\$12.95	INDIAN & MESA	2	200	34	x 16	2.12	1.78 - 2.56	28	
14-25	\$9.95	THE DESERT	24	70	21	x 60	0.35	0.26 - 0.45	12	
15-32	\$7.95	TEDDIE in WINDOW	15	87	23	x 19	1.21	1.00 - 1.42	16	
16-39	\$7.95	LILY SIDELIGHT	12	73	10	x 34	0.29	0.22 - 0.35	7	
16-40	\$8.95	TRUMPET VINE	12	112	35	x 35	1.00	0.77 - 1.27	18	
16-41	\$7.95	GEOMETRIC	19	42	10	x 45	0.22	0.15 - 0.35	6	
16-44	\$6.95	LIGHT HOUSE	21	51	14	x 23	0.61	0.40 - 0.80	9	
16-47	\$7.95	FLORAL SIDELIGHT	12	75	8	x 34	0.24	0.17 - 0.35	6	
16-48	\$8.95	1/4 Round with ROSE	12	116	31	x 31	1.00	0.75 - 1.30	24	
16-50	\$6.95	1/2 GEOMETRIC Door	6	44	23	x 12	1.92	1.50 - 2.50	14	
16-51	\$6.95	GEOMETRIC SIDELT	12	56	8	x 34	0.24	0.14 - 0.33	6	
16-52	\$7.95	TWO PARROTS	9	108	10	x 23	0.43	0.30 - 0.50	7	
16-53	\$8.95	SEASHELL	20	230	35	x 35	1.00	0.77 - 1.23	20	
16-54	\$7.95	Underwater SHELL	20	84	35	x 35	1.00	0.79 - 1.40	16	
16-55	\$11.95	WATER MILL SCENE	5	473	30	x 35	0.86	0.66 - 1.15	23	
16-60	\$9.95	1/2 ROUND	9	161	46	x 23	2.00	1.75 - 2.70	24	
17-463	\$9.95	OLD WORLD 4' Dome	22	668	Requires dome frame #4850					
18-65	\$11.95	FISHERMAN AT SEA	11	86	23	x 46	0.50	0.38 - 0.65	12	
18-66	\$11.95	23 THIRD PSALM	4	183	23	x 46	0.50	0.46 - 0.65	18	
18-67	\$11.95	EYE OF GOD Shining	11	112	30	x 59	0.51	0.39 - 0.61	16	
18-68	\$12.95	RIVER OF LIFE	4	144	23	x 46	0.50	0.38 - 0.65	14	
18-69	\$11.95	TRIAGE River of Life	11	169	23	x 46	0.50	0.41 - 0.56	16	
18-70	\$11.95	River of Life / Bush	11	268	23	x 46	0.50	0.38 - 0.65	16	
18-71	\$7.95	LIGHTHOUSE	25	109	20	x 20	1.00	0.80 - 1.20	15	
18-72	\$7.95	GOLDEN LABRADOR	6	69	23	x 23	1.00	0.82 - 1.15	14	
18-74	\$5.95	SEA LION on ROCKS	9	37	23	x 12	1.92	1.53 - 2.40	16	
18-75	\$6.95	VICTORIAN ROSE	12	106	23	x 19	1.21	1.00 - 1.57	17	
19-77	\$6.95	LARGE WAVE	25	31	18	x 30	0.60	0.40 - 1.10	9	
19-89	\$8.95	TRELLIS GRILLE	23	101	12	x 40	0.30	0.20 - 0.50	5	
19-90	\$11.95	LEAVES & Trellises	22	168	11	x 71	0.15	0.15 - 0.23	9	
20-02	\$9.95	BIRDS ON BRANCH	9	36	11	x 44	0.25	0.18 - 0.28	8	
20-04	\$19.95	BAPTISM OF JESUS	1	240	35	x 46	0.76	0.60 - 1.00	30	
20-05	\$8.95	DESCENDING DOVE	11	33	23	x 46	0.50	0.40 - 0.70	10	
20-06	\$8.95	CHALLIS & WAFER	11	258	23	x 46	0.50	0.38 - 0.65	12	
20-07	\$7.95	CROSS	4	21	14	x 21	0.67	0.40 - 0.93	8	
20-91	\$19.95	FLOWER BOUQUET	3	217	34	x 44	0.77	0.60 - 1.00	24	
20-92	\$8.95	THE VINEYARD	5	128	22.5	x 34	0.66	0.50 - 0.73	13	
20-93	\$7.95	HUMMINGBIRD	9	76	23	x 30	0.77	0.60 - 1.00	12	
20-94	\$6.95	CALLA LILIES	13	60	23	x 32	0.72	0.57 - 0.80	14	
20-95	\$7.95	LILY PADS	13	80	23	x 32	0.72	0.57 - 0.93	12	
20-96	\$7.95	SWAN	9	101	23	x 32	0.72	0.55 - 0.92	16	
20-97	\$9.95	Prairie Door Floral	13	105	22	x 46	0.48	0.33 - 0.62	10	

Pattern Listing of PRICES, Standard SIZES, Range of Acceptable Width / Height Ratios, Number of Pieces in Pattern

1/98 Edition (All measurements in INCHES)

Pattern Number	Price	Pattern Name	Catlg. Page	N° of Pieces	Standard Pattern Size		Std. Size W/H Ratio	Acceptable Ratio Range for Custom Sizing		Min. Width
					Width	x Height		Min	Max	
20-99	\$9.95	Prairie Door Vines	22	65	22	x 46	0.48	0.35 - 0.60	12	
21-15	\$8.95	ANGEL MUSICIAN	4	111	23	x 21	1.10	0.82 - 1.25	17	
21-20	\$11.95	WATERWHEEL	6	327	23	x 46	0.50	0.40 - 0.65	18	
21-21	\$6.95	FISH	6	37	22	x 12	1.83	1.40 - 2.16	12	
21-23	\$6.95	ROOSTER	9	41	10	x 20	0.50	0.38 - 0.60	7	
21-24	\$6.95	ROSE	13	51	13	x 20	0.65	0.50 - 0.75	9	
21-25	\$6.95	Cherry & ROOSTER	3	58	10	x 15	0.67	0.52 - 0.79	7	
21-26	\$12.95	ASCENSION ROBE	4	155	22	x 40	0.55	0.45 - 0.66	12	
22-427	\$9.95	DOGWOOD 4' Dome	23	1363	Requires dome frame #4850					
23-32	\$6.95	ANGEL DIANE	4	38	14	x 18	0.78	0.58 - 0.90	9	
23-35	\$6.95	SHAR-PEI PUPPY	15	42	18	x 12	1.50	1.20 - 2.00	12	
23-38	\$12.95	GEOMETRIC Skylight	6	406	35	x 35	1.00	0.80 - 1.25	18	
23-70	\$6.95	Persian CAT LAMP	15	43	8	x 9	0.89	0.89 - 0.89	8	
24-01	\$7.95	PRAIRIE DESIGN	17	82	17	x 34	0.50	0.40 - 0.62	8	
24-02	\$7.95	PRAIRIE DESIGN	17	109	22	x 34	0.65	0.52 - 0.80	11	
24-03	\$7.95	PRAIRIE DESIGN	18	66	22	x 34	0.65	0.52 - 0.80	11	
24-04	\$8.95	PRAIRIE DESIGN	18	86	23	x 23	1.00	0.80 - 1.25	11	
24-05	\$7.95	PRAIRIE DESIGN	18	78	23	x 23	1.00	0.80 - 1.25	11	
24-06	\$8.95	PRAIRIE DESIGN	18	95	23	x 28	0.82	0.65 - 1.02	11	
24-07	\$6.95	PRAIRIE DESIGN	18	63	11	x 34	0.32	0.25 - 0.40	6	
24-08	\$6.95	PRAIRIE DESIGN	18	87	11	x 34	0.32	0.25 - 0.40	6	
24-09	\$9.95	PRAIRIE DESIGN	18	173	23	x 28	0.82	0.65 - 1.02	11	
24-10	\$7.95	PRAIRIE DESIGN	18	80	23	x 23	1.00	0.80 - 1.25	11	
24-11	\$7.95	PRAIRIE DESIGN	19	75	23	x 23	1.00	0.80 - 1.25	11	
24-12	\$9.95	PRAIRIE DESIGN	18	226	21	x 42	0.50	0.40 - 0.62	11	
24-13	\$7.95	PRAIRIE DESIGN	18	60	23	x 34	0.68	0.52 - 0.81	11	
24-14	\$6.95	PRAIRIE DESIGN	18	72	22	x 28	0.79	0.65 - 1.00	11	
24-15	\$7.95	PRAIRIE DESIGN	19	65	23	x 23	1.00	0.80 - 1.25	11	
24-16	\$6.95	PRAIRIE DESIGN	19	116	23	x 23	1.00	0.80 - 1.25	11	
24-17	\$7.95	PRAIRIE DESIGN	19	81	23	x 28	0.82	0.65 - 1.02	11	
24-18	\$6.95	PRAIRIE DESIGN	17	84	11	x 33	0.33	0.25 - 0.40	6	
24-19	\$5.95	PRAIRIE DESIGN	17	61	8	x 23	0.35	0.25 - 0.40	5	
24-21	\$8.95	PRAIRIE DESIGN	19	91	30	x 30	1.00	0.80 - 1.25	15	
24-22	\$7.95	PRAIRIE DESIGN	19	114	16	x 32	0.50	0.40 - 0.63	8	
24-24	\$7.95	PRAIRIE DESIGN	19	88	23	x 27.5	0.84	0.65 - 1.00	11	
24-25	\$7.95	PRAIRIE DESIGN	19	154	23	x 30	0.77	0.63 - 1.00	11	
24-26	\$7.95	PRAIRIE DESIGN	19	69	23	x 23	1.00	0.80 - 1.25	11	
24-44	\$6.95	FEMALE GOLFER	8	23	18	x 24	0.75	0.60 - 1.00	7	
24-45	\$6.95	MALE GOLFER	8	27	13	x 24	0.54	0.48 - 0.67	7	
24-50	\$6.95	GIRL SOFTBALL	8	42	18	x 24	0.75	0.60 - 0.90	10	
24-51	\$6.95	BOY BASEBALL	8	27	18	x 24	0.75	0.53 - 0.95	8	
24-56	\$6.95	MALE TENNIS Player	8	28	18	x 24	0.75	0.56 - 0.90	9	
24-57	\$6.95	FEMALE TENNIS	8	26	15	x 24	0.62	0.50 - 0.71	9	
24-62	\$6.95	GIRL BASKETBALL	8	36	18	x 24	0.75	0.62 - 0.85	8	
24-63	\$6.95	BOYS BASKETBALL	8	31	18	x 24	0.75	0.56 - 0.88	10	
24-78	\$7.95	PRAIRIE DESIGN	16	96	28	x 34	0.82	0.65 - 1.02	14	
24-79	\$7.95	PRAIRIE DESIGN	16	105	28	x 34	0.82	0.65 - 1.02	14	
24-80	\$7.95	PRAIRIE DESIGN	16	105	23	x 23	1.00	0.80 - 1.25	11	
24-82	\$8.95	PRAIRIE DESIGN	16	68	22	x 34	0.65	0.52 - 0.80	11	
24-83	\$7.95	PRAIRIE DESIGN	16	103	23	x 29	0.79	0.64 - 1.00	11	
24-84	\$7.95	PRAIRIE DESIGN	16	141	23	x 27	0.85	0.70 - 1.10	11	
24-86	\$7.95	PRAIRIE DESIGN	16	56	23	x 23	1.00	0.80 - 1.25	11	
24-87	\$8.95	PRAIRIE DESIGN	16	100	21	x 34	0.62	0.50 - 0.82	11	
24-88	\$8.95	PRAIRIE DESIGN	16	98	22.5	x 34	0.66	0.55 - 0.83	11	
24-90	\$7.95	PRAIRIE DESIGN	16	64	23	x 32	0.72	0.55 - 0.86	11	

Pattern Listing of PRICES, Standard SIZES, Range of Acceptable Width / Height Ratios, Number of Pieces in Pattern

1/98 Edition (All measurements in INCHES)

Pattern Number	Price	Pattern Name	Catlg. Page	N° of Pieces	Standard Pattern Size		Std. Size W/H Ratio	Acceptable Ratio Range for Custom Sizing		Min. Width
					Width	x Height		Min	Max	
24-91	\$5.95	PRAIRIE DESIGN	17	48	10	x 30	0.33	0.25 - 0.40	6	
24-92	\$5.95	PRAIRIE DESIGN	17	51	10	x 30	0.33	0.25 - 0.40	6	
24-94	\$8.95	PRAIRIE DESIGN	17	88	30	x 30	1.00	0.80 - 1.25	15	
24-95	\$7.95	PRAIRIE DESIGN	17	62	23	x 28	0.82	0.65 - 1.02	11	
24-96	\$7.95	PRAIRIE DESIGN	17	75	23	x 34	0.68	0.52 - 0.80	11	
24-97	\$7.95	PRAIRIE DESIGN	17	120	23	x 26	0.88	0.70 - 1.10	11	
24-98	\$7.95	PRAIRIE DESIGN	17	91	17	x 34	0.50	0.40 - 0.62	8	
24-99	\$7.95	PRAIRIE DESIGN	17	77	23	x 23	1.00	0.80 - 1.25	11	
25-492	\$7.95	HUMMIGBIRD & MGs	9	210	23	x 23	1.00	0.79 - 1.10	18	
25-493	\$6.95	TOUCAN IN JUNGLE	9	178	23	x 23	1.00	0.85 - 1.17	16	
25-494	\$7.95	FLAMINGO COUPLE	9	150	15	x 34	0.44	0.36 - 0.60	12	
25-497	\$6.95	SWAN	9	159	23	x 27	0.85	0.71 - 1.05	19	
25-498	\$6.95	PELICAN ON POST	9	121	14	x 31	0.45	0.35 - 0.58	9	
25-499	\$9.95	EAGLE IN FLIGHT	10	221	40	x 28	1.43	1.23 - 1.70	20	
25-501	\$5.95	EAGLE'S HEAD	10	78	16	x 16	1.00	0.84 - 1.19	12	
25-504	\$6.95	FISH JUMPING	8	142	23	x 23	1.00	0.85 - 1.18	14	
25-508	\$6.95	HORSE'S HEAD	14	84	16	x 16	1.00	0.80 - 1.20	11	
25-509	\$8.95	CAROUSEL HORSE	20	207	18	x 23	0.78	0.59 - 0.90	14	
25-510	\$8.95	CAROUSEL HORSE	20	205	30	x 23	1.30	1.00 - 1.50	24	
25-511	\$8.95	CAROUSEL HORSE	20	178	20	x 32	0.62	0.55 - 0.69	14	
25-512	\$11.95	CAROUSEL Horses	1	478	46	x 28	1.64	1.27 - 1.75	35	
25-515	\$7.95	BAMBOO	5	131	20	x 20	1.00	0.72 - 1.20	15	
25-516	\$9.95	BAMBOO Sidelights (2)	24	239	11	x 34	0.32	0.20 - 0.50	9	
25-518	\$7.95	VOLCANO	25	159	23	x 23	1.00	0.75 - 1.25	16	
25-520	\$7.95	TROPICAL LAGOON	22	222	18	x 28	0.64	0.50 - 0.78	14	
25-522	\$9.95	LIGHTHOUSE	22	94	42	x 30	1.40	1.07 - 1.80	28	
25-538	\$7.95	ALGERIAN IRIS	22	109	23	x 23	1.00	0.79 - 1.20	16	
25-565	\$7.95	CATTAIL SIDELITES (2)	25	101	9	x 34	0.26	0.18 - 0.32	6	
25-573	\$7.95	ASIAN DOGWOOD	13	92	23	x 23	1.00	0.76 - 1.30	14	
25-574	\$7.95	IRIS MIRROR	22	102	22	x 34	0.65	0.55 - 0.82	14	
25-579	\$6.95	Northern CARDINAL	11	116	18	x 30	0.60	0.50 - 0.74	14	
25-580	\$6.95	COCKATIEL	10	95	16	x 24	0.67	0.61 - 0.73	12	
25-583	\$7.95	MALLARD FLYING	8	150	23	x 23	1.00	0.82 - 1.22	16	
25-586	\$9.95	PHEASANT FLYING	8	315	20	x 34	0.59	0.50 - 0.70	12	
25-587	\$6.95	BIGHORN SHEEP	14	73	23	x 23	1.00	0.83 - 1.10	16	
25-589	\$6.95	ELK FORAGING	14	82	20	x 20	1.00	0.80 - 1.15	16	
25-591	\$7.95	POLAR BEAR	15	60	18	x 30	0.60	0.50 - 0.72	12	
25-594	\$9.95	STAG in the Mountain	3	123	23	x 31	0.74	0.58 - 0.89	18	
25-595	\$7.95	HOUND DOGS	14	74	23	x 29	0.79	0.67 - 0.95	15	
25-597	\$7.95	HOUSE CAT	14	59	20	x 20	1.00	0.80 - 1.20	12	
25-599	\$7.95	SIAMESE CAT	15	49	16	x 26	0.62	0.55 - 0.75	11	
25-600	\$8.95	DEEP SEA FISH	3	169	23	x 23	1.00	0.80 - 1.20	14	
25-601	\$7.95	FISH & LURE	6	131	23	x 23	1.00	0.82 - 1.18	16	
25-603	\$7.95	TROPICAL FISH	15	121	16	x 23	0.70	0.53 - 0.82	12	
25-605	\$8.95	QUARTERBACK	8	101	18	x 34	0.53	0.40 - 0.65	12	
25-607	\$8.95	ROCK CLIMBER	8	96	18	x 34	0.53	0.33 - 0.66	12	
25-611	\$8.95	HIGH FASHION LADY	23	71	16	x 32	0.50	0.38 - 0.60	12	
25-612	\$8.95	HIGH FASHION MAN	23	67	16	x 32	0.50	0.38 - 0.60	12	
25-613	\$8.95	PEONY FAN	13	148	28	x 18	1.56	1.12 - 2.00	17	
25-614	\$8.95	IRIS FAN	13	143	28	x 18	1.56	1.25 - 1.66	18	
25-615	\$10.95	GEISHA with Lantern	6	144	20	x 32	0.62	0.50 - 0.70	13	
25-616	\$7.95	GEISHA with FAN	25	89	20	x 20	1.00	0.80 - 1.15	14	
25-617	\$10.95	GEISHA with BOOK	24	90	20	x 32	0.62	0.48 - 0.72	15	
25-618	\$9.95	PEACOCK	10	209	20	x 32	0.62	0.44 - 0.75	15	
25-619	\$7.95	TOUCANS	10	124	18	x 28	0.64	0.47 - 0.75	12	

Pattern Listing of PRICES, Standard SIZES, Range of Acceptable Width / Height Ratios, Number of Pieces in Pattern

1/98 Edition (All measurements in INCHES)

Pattern Number	Price	Pattern Name	Catlg. Page	N° of Pieces	Standard Pattern Size		Std. Size W/H Ratio	Acceptable Ratio Range for Custom Sizing		Min. Width
					Width	x Height		Min	Max	
25-620	\$7.95	MACAWS	10	121	18	x 28	0.64	0.50 - 0.70	12	
25-621	\$8.95	BIRDS with PEONIES	10	150	20	x 20	1.00	0.75 - 1.18	16	
25-622	\$8.95	DOVES	10	149	27	x 18	1.50	1.17 - 1.94	17	
25-624	\$7.95	FLAMINGO	10	123	10	x 34	0.29	0.23 - 0.35	8	
25-625	\$7.95	CHICKADEES , Aspen	10	134	28	x 18	1.56	1.22 - 1.83	20	
25-626	\$7.95	NIGHT OWL	10	110	28	x 18	1.56	1.25 - 2.00	19	
25-627	\$8.95	SWAN & Water LILY	10	136	30	x 20	1.50	1.18 - 1.80	15	
25-628	\$7.95	PUFFINS	10	97	18	x 28	0.64	0.50 - 0.75	12	
25-629	\$7.95	POLAR BEAR	15	115	28	x 18	1.56	1.35 - 1.75	17	
25-630	\$7.95	TIGER	15	92	20	x 20	1.00	0.91 - 1.05	15	
25-631	\$7.95	WINDOW CATS	14	139	20	x 24	0.83	0.66 - 1.04	14	
25-632	\$9.95	CAT QUINTET	15	219	42	x 21	2.00	1.50 - 2.30	24	
25-633	\$7.95	ROOSTER	10	72	18	x 28	0.64	0.50 - 0.82	10	
25-634	\$7.95	GEESE	11	89	28	x 14	2.00	1.56 - 2.50	14	
25-635	\$7.95	KITCHEN SCENE	23	65	28	x 18	1.56	1.15 - 2.00	14	
25-636	\$8.95	COUNTRY ANIMALS	15	150	18	x 34	0.53	0.40 - 0.69	12	
25-637	\$9.95	ROCKING HORSE	15	137	32	x 23	1.39	1.00 - 1.65	20	
25-638	\$8.95	NOAH'S ARK	15	137	30	x 23	1.30	1.00 - 1.60	20	
25-639	\$8.95	PIERROT	20	149	23	x 26	0.88	0.64 - 1.15	16	
25-640	\$7.95	JUGGLING CLOWN	21	103	23	x 23	1.00	0.80 - 1.20	16	
25-641	\$8.95	TEDDY BEARS	15	149	33	x 20	1.65	1.32 - 2.15	24	
25-646	\$8.95	SANTA	3	157	23	x 23	1.00	0.82 - 1.15	18	
25-647	\$7.95	ORIENTAL IRISES	22	99	10	x 34	0.29	0.22 - 0.40	8	
25-650	\$7.95	ROSES IN HEART	25	91	20	x 20	1.00	0.83 - 1.25	13	
25-652	\$8.95	Butterflies, ROSES	13	151	20	x 20	1.00	0.70 - 1.30	14	
25-653	\$6.95	TULIP BULB	13	46	12	x 32	0.38	0.29 - 0.48	7	
25-654	\$6.95	DAFFODIL BULB	13	50	12	x 32	0.38	0.30 - 0.48	7	
25-655	\$7.95	ORCHIDS	13	128	18	x 32	0.56	0.43 - 0.65	12	
25-656	\$8.95	TENNIS PLAYER	8	101	18	x 32	0.56	0.45 - 0.69	14	
25-657	\$9.95	MAN & LADY	20	94	11	x 24	0.46	0.35 - 0.63	7	
25-658	\$8.95	DANCERS	21	102	23	x 31	0.74	0.58 - 0.95	16	
25-659	\$8.95	ENCHANTED Prince	20	125	18	x 32	0.56	0.40 - 0.65	12	
25-660	\$8.95	ENCHANTED Princess	20	122	18	x 32	0.56	0.40 - 0.65	12	
25-661	\$9.95	RODEO COWBOY	20	161	18	x 28	0.64	0.50 - 0.79	12	
25-662	\$9.95	KING ON HORSE	20	161	32	x 23	1.39	1.07 - 1.65	18	
25-663	\$8.95	DRAGON	20	99	20	x 20	1.00	0.77 - 1.20	14	
25-664	\$8.95	UNICORN GARDEN	15	210	20	x 34	0.59	0.50 - 0.77	12	
25-665	\$8.95	HOT AIR BALLOONS	8	158	22	x 34	0.65	0.57 - 0.76	11	
25-666	\$10.95	CAROUSEL HORSE	20	257	30	x 23	1.30	0.95 - 1.43	20	
25-667	\$8.95	ROADSTER	6	104	32	x 18	1.78	1.28 - 2.00	24	
25-668	\$7.95	CLASSIC CAR	23	85	23	x 20	1.15	0.95 - 1.40	14	
25-669	\$7.95	COTTAGE in the Hills	25	81	34	x 22	1.55	1.00 - 2.00	16	
25-671	\$8.95	AIRPLANE	23	95	34	x 14	2.43	1.80 - 2.70	24	
25-672	\$7.95	LIGHTHOUSE	24	56	18	x 30	0.60	0.50 - 0.80	10	
26-26	\$8.95	BIRDS OF CANTON	11	207	23	x 27	0.85	0.65 - 1.00	16	
26-27	\$7.95	QUAIL'S NEST	11	132	30	x 30	1.00	0.85 - 1.15	20	
26-30	\$6.95	STRAWBERRY	13	77	23	x 23	1.00	0.80 - 1.12	14	
26-35	\$10.95	DOGWOOD	23	133	14	x 72	0.19	0.15 - 0.24	9	
26-36	\$6.95	FLEUR DE LIS	25	67	23	x 23	1.00	0.80 - 1.21	12	
26-73	\$7.95	IRIS	25	40	16	x 19	0.84	0.66 - 1.10	10	
26-74	\$7.95	LOVEBIRDS	11	55	17	x 23	0.74	0.60 - 0.85	10	
26-75	\$7.95	CHINA PATTERN	13	76	16	x 33	0.48	0.33 - 0.60	9	
26-76	\$5.95	DOVE with BRANCH	11	35	16	x 16	1.00	0.72 - 1.18	10	
26-77	\$10.95	IRIS GARDEN	13	193	12	x 72	0.17	0.14 - 0.22	8	
26-78	\$5.95	VICTORIAN TULIP	22	58	13	x 16	0.81	0.56 - 1.10	10	

Pattern Listing of PRICES, Standard SIZES, Range of Acceptable Width / Height Ratios, Number of Pieces in Pattern

1/98 Edition (All measurements in INCHES)

Pattern Number	Price	Pattern Name	Catlg. Page	N° of Pieces	Standard Pattern Size		Std. Size W/H Ratio	Acceptable Ratio Range for Custom Sizing		Min. Width
					Width	x Height		Min	Max	
26-79	\$10.95	Hummingbird & Posies	10	169	11	x 23	0.48	0.35 - 0.60	8	
26-80	\$14.95	Butterflies & Roses	23	335	10	x 45	0.22	0.15 - 0.29	8	
26-82	\$8.95	VICTORIAN CIRCLE	24	98	23	x 23	1.00	0.75 - 1.25	16	
26-83	\$9.95	PANSIES	14	136	23	x 30	0.77	0.67 - 1.00	15	
26-84	\$9.95	ANTIQUE FLORAL	14	165	17	x 34	0.50	0.38 - 0.62	13	
26-86	\$11.95	HERON	10	166	13	x 51	0.25	0.18 - 0.35	11	
26-87	\$11.95	HAWAIIAN Nights #2	24	187	23	x 46	0.50	0.38 - 0.60	15	
26-88	\$10.95	EASTERN FLARE	14	170	14	x 68	0.21	0.17 - 0.26	10	
26-90	\$11.95	HAWAIIAN Nights #1	24	163	23	x 41	0.56	0.45 - 0.81	15	
26-91	\$8.95	STYLIZED FLORAL	14	156	17	x 73	0.23	0.18 - 0.28	12	
26-92	\$10.95	ORIENTAL RUG	19	182	22	x 46	0.48	0.35 - 0.70	14	
27-61	\$6.95	WINDOW/MIRROR	24	48	12	x 34	0.35	0.23 - 0.50	8	
27-62	\$7.95	FLORAL Door Panel	23	55	18	x 28	0.64	0.50 - 0.75	12	
27-63	\$7.95	GEOMETRIC Design	19	47	9	x 46	0.20	0.13 - 0.45	6	
27-65	\$9.95	STYLIZED FLORAL	14	47	13	x 78	0.17	0.12 - 0.20	9	
27-66	\$8.95	PUEBLO RAINBIRD	11	39	34	x 34	1.00	0.50 - 1.80	12	
27-67	\$8.95	ART DECO DESIGN	19	50	21	x 45	0.47	0.33 - 0.67	10	
30-402	\$9.95	HONEYCOMB 4' Dome	23	513	Requires dome frame #4850					
30-403	\$9.95	DECO 4' DOME	23	405	Requires dome frame #4850					
30-404	\$9.95	FLOWER 4' DOME	23	487	Requires dome frame #4850					
30-405	\$9.95	FEATHERS 4' DOME	23	432	Requires dome frame #4850					
30-602	\$14.95	HONEYCOMB 6' Dome	ns	667	Requires dome frame #6250					
30-702	\$19.95	HONEYCOMB 7' Dome	ns	667	Requires dome frame #7250					
31-11	\$9.95	UNDER SEA	22	55	9	x 34	0.26	0.17 - 0.35	6	
32-730	\$19.95	SHELL 7' DOME	25	1171	Requires dome frame #7250					
32-830	\$23.95	SHELL 8' DOME	ns	1545	Requires dome frame #8650					
33-401	\$9.95	FISH BOWL 4' DOME	23	652	Requires dome frame #4850					
50-101	\$15.95	SCROLL 10' DOME	25	661	Requires dome frame #10450					
50-102	\$34.95	VICTORIAN 10' Dome	ns	5653	Requires dome frame #10450					
50-422	\$7.95	BORDERED 4' DOME	ns	153	Requires dome frame #4850					
50-621	\$11.95	CASCADE 6' DOME	24	433	Requires dome frame #6250					
50-622	\$8.95	BORDERED 6' DOME	ns	253	Requires dome frame #6250					
50-623	\$12.95	NOUVEAU 6' DOME	24	823	Requires dome frame #6250					
50-624	\$9.95	NAVAJO 6' DOME	24	521	Requires dome frame #6250					
50-626	\$9.95	WEB 6' DOME	24	641	Requires dome frame #6250					
50-707	\$10.95	LOTUS 7' DOME	24	657	Requires dome frame #7250					
50-721	\$12.95	CASCADE 7' DOME	24	433	Requires dome frame #7250					
50-722	\$8.95	BORDERED 7' DOME	ns	253	Requires dome frame #7250					
50-723	\$13.95	NOUVEAU 7' DOME	24	823	Requires dome frame #7250					
50-724	\$10.95	NAVAJO 7' DOME	24	521	Requires dome frame #7250					
50-726	\$10.95	WEB 7' DOME	24	641	Requires dome frame #7250					
50-802	\$24.95	VICTORIAN 8' DOME	25	2977	Requires dome frame #8650					
50-807	\$15.95	PRAIRIE 8' DOME	ns	1249	Requires dome frame #8650					
50-808	\$14.95	SAVOY 8' DOME	25	732	Requires dome frame #8250					
50-821	\$13.95	CASCADE 8' DOME	24	433	Requires dome frame #8250					
50-822	\$9.95	BORDERED 8' DOME	ns	253	Requires dome frame #8250					
50-824	\$11.95	NAVAJO 8' DOME	24	521	Requires dome frame #8250					
50-826	\$11.95	WEB 8' DOME	24	641	Requires dome frame #8250					
50-861	\$14.95	CASCADE 8' DOME	ns	642	Requires dome frame #8650					
50-862	\$9.95	BORDERED 8' DOME	ns	333	Requires dome frame #8650					
50-863	\$15.95	NOUVEAU 8' DOME	ns	1049	Requires dome frame #8650					
50-866	\$12.95	WEB 8' DOME	ns	505	Requires dome frame #8650					